

Clinton

INSTRUMENT COMPANY

Models DC-1, -10 and -20B DC Spark Testers
Instruction Manual



DC-20B/BD-12S shown with optional X3B Horn/Light Tower

Clinton Instrument Company

295 East Main Street
Clinton, CT 06413 USA
Telephone: 860.669.7548 Fax: 860.669.3825
www.clintoninstrument.com

Rev A b0004 11/8/23

Contents

DECLARATION OF CONFORMITY	5
SPECIFICATIONS	6
SAFETY	8
SAFETY SYMBOL	8
ENVIRONMENTAL CONDITIONS.....	8
AVOID THE RISK OF FIRE!	9
CAUTION: PACEMAKER WARNING	9
ELECTRICAL SHOCK HAZARD FROM PRODUCTION LINE SPARK TESTERS.....	9
INSTALLATION	11
CAUTION:.....	11
UNPACKING.....	11
SITE PREPARATION.....	12
<i>Select a suitable location for the spark tester:</i>	12
<i>To mount the unit on a horizontal surface:</i>	12
<i>To install the unit on a Clinton floor stand:</i>	12
<i>To install RC Display onto the DC-B</i>	13
<i>Provide for ventilation of the Test Module</i>	13
POWER WIRING	13
<i>Install an external disconnecting device</i>	13
<i>Mains Power</i>	13
<i>Ground the Spark Tester</i>	13
TERMINAL BLOCK WIRING.....	14
CONNECTING THE SERIAL RS-485	16
CONNECTING TO THE ANALOG INTERFACE (OPTIONAL)	16
INSTALLING THE COMPACTCOM™ MODULE (OPTIONAL)	16
CONNECTING THE X3B (OPTIONAL)	17
<i>Unpacking the X3B</i>	17
<i>Connecting the X3B</i>	17
<i>X3B to Spark Tester Connections</i>	18
SPARK TESTER CONTROLS	19
<i>ON/OFF Power Switch</i>	19
<i>Voltmeter</i>	19
<i>“A” Button</i>	19
<i>UP/DOWN ARROW (VOLTAGE ADJUST) buttons</i>	19
<i>Fault Counter</i>	19
<i>“B” Button</i>	19
<i>“CR” COUNT RESET button</i>	19
<i>FAULT light</i>	20
<i>“R” RESET button</i>	20
<i>High Voltage On Lamp</i>	20
<i>Bead Chain Electrode</i>	20
<i>Clear Protective Cover</i>	20
<i>Safety Interlock switch</i>	20
<i>Safety end guards</i>	20
DEFINITION OF TERMS	21

NEW FEATURES	22
DISPLAY:	22
FRONT PANEL SECURITY	22
BD-12S DESIGN (PATENT PENDING)	22
COMMUNICATION MODULES	23
VOLTAGE WATCHDOG	23
FAULT TYPING	23
BACKWARDS COMPATIBLE	23
SPARK TESTER CONFIGURATION (FRONT PANEL)	24
NAVIGATING THE CONFIGURATION MENU	24
RC DISPLAY SECURITY (PIN)	24
CONFIGURATION MENU OPTIONS	25
SPARK TESTER INPUTS	32
<i>High Voltage Enable (HVE)</i>	<i>32</i>
<i>Fault Reset (FR)</i>	<i>32</i>
SPARK TESTER OUTPUTS	32
GENERAL OUTPUTS	32
<i>Output Disabled (OFF)</i>	<i>32</i>
<i>Cover Open (CVO):</i>	<i>32</i>
<i>System OK (SOK)</i>	<i>32</i>
<i>Discharge Bar (DIS)</i>	<i>33</i>
<i>High Voltage Enable (HVE)</i>	<i>33</i>
VOLTAGE MONITOR OUTPUT OPTIONS	33
<i>High Voltage On Lamp (HVL)</i>	<i>33</i>
<i>High Voltage Watchdog (WDL)</i>	<i>33</i>
<i>Electrode Voltage Percent Based Watchdog (EVP)</i>	<i>34</i>
<i>Actual Voltage Percent Based Watchdog (AVP)</i>	<i>34</i>
<i>Percent Load Limit (PLL)</i>	<i>34</i>
FAULT OUTPUT OPTIONS	34
<i>Fault Pulse (FPL)</i>	<i>34</i>
<i>Any Fault Alarm (AFA)</i>	<i>35</i>
<i>Pinhole Alarm (PHA)</i>	<i>35</i>
<i>Metal Contact Alarm (MCA)</i>	<i>36</i>
<i>Multi Pinhole Alarm (MPA)</i>	<i>36</i>
<i>Gross Barewire Alarm (GBA)</i>	<i>36</i>
<i>Any Fault Limit (AFL)</i>	<i>37</i>
<i>Pinhole Limit (PHL)</i>	<i>37</i>
<i>Metal Contact Limit (MCL)</i>	<i>37</i>
<i>Multi Pinhole Limit (MPL)</i>	<i>37</i>
<i>Gross Barewire Limit (GBL)</i>	<i>38</i>
<i>Fault Combination Limit (FCL) – Must be configured via USB computer interface</i>	<i>38</i>
<i>Any Barewire Alarm (ABW)</i>	<i>38</i>
<i>Any Pinhole Alarm (APH)</i>	<i>38</i>
FAULT TYPING	40
PINHOLE	40
DIRECT METAL CONTACT	40
MULTI PINHOLE	40

<i>GROSS BAREWIRE</i>	40
SPARK TESTER CONFIGURATION (USB)	41
TESTING YOUR PRODUCT	42
PREPARING YOUR PRODUCT FOR TESTING	42
RS-485 INTERFACE	43
RS-485 CONNECTOR	43
RS-485 PARAMETERS	43
ANALOG INTERFACE	44
ANALOG INTERFACE PIN FUNCTIONS	44
FIELDBUS COMMUNICATIONS INTERFACE	45
FIELDBUS COMMUNICATIONS PARAMETERS	45
FIELDBUS SPARK TESTER PARAMETER ADDRESSES	46
CIC XM UTILITY.....	47
CALIBRATION	50
ST-CAL CALIBRATION	50
EVM CALIBRATION PROCEDURE.....	50
<i>Connecting the EVM</i>	50
<i>Taking Calibration Readings</i>	51
<i>Adjusting the Calibration</i>	51
MAINTENANCE	52
FUSES.....	52
PERIODIC INSPECTION.....	52
TROUBLESHOOTING	54
SETTING FACTORY DEFAULTS	55
REPLACEMENT PARTS	56
OPTIONAL ACCESSORIES	57
FS-4 FLOOR STAND ASSEMBLY	59
GROUNDING OF CONDUCTORS DURING THE SPARK TEST	60

EU Declaration of Conformity



We

The Clinton Instrument Company
295 East Main Street
Clinton, CT 06413
USA
support@clintoninstrument.com

declare that the Declaration of Conformity is Issued under our sole responsibility and belongs to the following 1kV, 10kV and 20kV products:

Model: DC-XXB Series	Negative DC Spark Tester
Model: DC-XXBA	Negative DC Spark Tester with Analog Module
Model: HF-XXBX	Negative DC Spark Tester with Fieldbus Module

The object of the declaration described above is in conformity with the relevant Union Harmonization legislation:

2014/30/EU EMC Directive
2014/35/EU Low-Voltage Directive

The following Harmonized standards and technical specifications have been applied:

CISPR 11 Edition 5.0: 2009, A1: 2010	Conducted Emissions, Group 1, Class A
CISPR 11 Edition 5.0: 2009, A1: 2010	Radiated Emissions, Group 1, Class A
IEC 61000-4-2: 2008	Electrostatic Discharge
IEC 61000-4-3: 2006, A1:2007, A2:2010	Radiated Immunity
IEC 61000-4-4: 2004, A1: 2010	EFT/Burst, Power Ports and I/O Ports
IEC 61000-4-5: 2005	Surge Immunity, Power Ports
IEC 61000-4-6: 2008	Conducted Immunity, Power Ports and I/O Ports
IEC 61000-4-11: 2004	Voltage Dips and Interrupts
IEC 61010-1J: 2018	Safety Requirements

Clinton, CT USA September 2018

Donna Langley
President

Ted P. Lane
Chief Engineer

Specifications

MODEL DC-xxB

Digital Spark Tester

- Split electrode design for easy string-up **
- DSP based voltage regulation and differentiation of four fault-types **
- LED Display viewable up to 200 feet away
- Customizable front panel password security
- Voltage Watchdog
- Percent load meter
- Automatic calibration with Clinton STCAL System
- Communications: Modbus RTU via RS-485
Optional: Analog, Ethernet/IP, Modbus TCP, Profibus, PROFINET, DeviceNET

The Clinton model DC-B DC Spark Tester combines the latest in technology and innovative features for DC spark testing of wire and cable.

Using DSP based fault typing the DC-B can differentiate between four fault conditions: pinhole, direct metal contact, multi-pinhole and gross bare wire.

The new BD-12S split electrode design provides an easy way to string-up wire through the electrode, guaranteeing precise center alignment for the most effective and reliable testing. The bead chain assemblies are positioned to eliminate gaps between bead rows, providing the best coverage around the product at all times.

The DC-B can be quickly configured for respooling or extrusion operations through a simple menu on the alphanumeric display. During spark testing, critical data such as test voltage, percent load, and counts for particular fault types can be easily accessed. Additionally, descriptive codes inform the operator when there is an error. For example, when the protective electrode cover is open.

The display model can be mounted to the unit as shown, or can be installed up to 200 feet away.

DC-10B/BD-12S with RC Control



The DC-B can connect easily to a PLC with Modbus RTU via RS-485 full duplex. Optional Analog, DeviceNET, Ethernet/IP, PROFINET, Profibus, and Modbus TCP communications are available.

Wiring and setup is done externally; there is no need to open the unit. One form C and three for A relay contacts are located on the rear panel for easy connection to external alarms, lights, or machinery controlled by the spark tester. Relay function may be selected from options including: high voltage ON indication, fault alarm, bare wire alarm, and voltage watchdog (when enabled, the equipment will alert when a preset upper or lower voltage is exceeded). The DC-B features a flexible front panel password security, locking out unauthorized changes to test voltage and other settings. The unit also monitors output voltage at the electrode and notifies the operator if voltage at the electrode should become disconnected.

The DC-B spark tester series offers standard electrodes that meet UL, CSA, and all known international standards for wire products and production line speeds. Specifically designed electrodes are available to accommodate a wide range of product sizes and shapes.

The DC-B can be automatically calibrated for voltage to IEC/CEI 6230, EN 50356, UL and NEMA standards with the Clinton Instrument STCAL system.

Clinton
INSTRUMENT COMPANY

DC-B SPECIFICATIONS

Voltage Test Range:	
DC-1B	50 Volts to 1kV DC
DC-10B	500 Volts to 10kV DC
DC-20B	500 Volts to 20kV DC
Voltage Accuracy	+/- 2% of reading
Output Power	
DC-1B	2.0 mA maximum
DC-10B	1.5 mA maximum
DC-20B	0.75 mA maximum
Fault Indication	White 3-digit 20.32mm high LED display, amber fault indicating LED
Fault Resolution	Variable with electrode length or directly configurable from 1 millisecond to 2 seconds
Detection Sensitivity	Conforms to IEC 62230
Operating Modes	Continuous HV/remove voltage on fault, momentary process control/latch until reset
Relay Outputs	1 Form C, 3 Form A / Configurable Functionality Relay contacts rated 1A max @ 240VAC or 2A max @ 120VAC for both NO and NC circuits. Front panel or external reset. In non-latch modes, closure time is adjustable in 10 millisecond increments from 50 milliseconds to 2 ½ seconds
Power Requirements	100 to 240VAC 49-61 Hz. Power supply self-adjusting
Safety	Designed to IEC-1010
Communications	Modbus RTU via RS-485
Optional Communications	Analog, Ethernet IP, Modbus TCP, Profibus,
Communications	Profinet, DeviceNET

DC-B ELECTRODES

Bead Chain Assemblies	
BD-12S	Bead Chain Assembly ¼" Product Diameter, 2" along the wire line.
BD-13S	Bead Chain Assembly ¼" Product Diameter, 3" along the wire line.
BD-14S	Bead Chain Assembly ¼" Product Diameter, 4" along the wire line.
BD-15	Bead Chain Assembly ¼" Product Diameter, 5" along the wire line.
BD-22S	Bead Chain Assembly 2" Product Diameter, 2" along the wire line.
Brush Assemblies	
BR-1A	Brush Assembly Phosphor Bronze 1" Product Diameter.
BR-1ALZ	Brush Assembly Phosphor Bronze 1" Product Diameter, 10kV max.
BR-3A	Brush Assembly Phosphor Bronze 3" Product Diameter.
BR-3ALZ	Brush Assembly Phosphor Bronze 3" Product Diameter, 10kV max.
BRTC-6LZ	Brush Assembly Tape Cable 6", 10kV max.
BRTC-12LZ	Brush Assembly Tape Cable 12", 10kV max.
FB-12	Fiberlite Brush Assembly.
Roller Assemblies	
R-46	Roller Assembly .2" (6mm) max. Product Thickness, 6" (152mm) Product Width.

Dimensions For DC-xxB With No Display

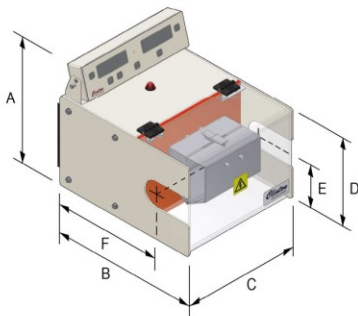

	A	B	C	D	Wireline Center	
					Vertical	Horizontal
BD-12S, 13S, 14S, BR-1A, BR-1ALZ, FB-12	11.3" [287 mm]	13.9" [353 mm]	11.5" [293 mm]	7.5" [190 mm]	3.8" [95 mm]	10.0" [254 mm]
BD-22S	12.3" [312 mm]	15.4" [391 mm]	11.6" [294 mm]	8.5" [216 mm]	4.3" [109 mm]	11.0" [279 mm]
BD-15	13.2" [335 mm]	16.3" [414 mm]	12.5" [318 mm]	9.4" [240 mm]	4.8" [120 mm]	11.5" [290 mm]
BR-3A, BR-3ALZ	13.2" [335 mm]	17.8" [452 mm]	13.5" [343 mm]	9.4" [240 mm]	Call factory for details	
BRTC-6	13.2" [335 mm]	19.1" [485 mm]	12.5" [318 mm]	9.4" [240 mm]	Call factory for details	

Dimensions For DC-xxB With No Display

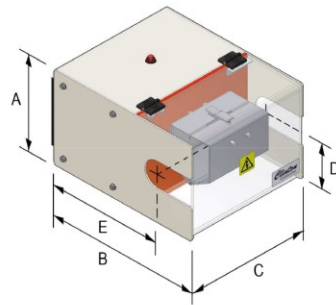

	A	B	C	Wireline Center	
				Vertical	Horizontal
BD-12S, 13S, 14S, BR-1A, BR-1ALZ, FB-12	7.5" [190 mm]	13.9" [353 mm]	11.5" [293 mm]	3.8" [95 mm]	10.0" [254 mm]
BD-22S	12.3" [312 mm]	15.4" [391 mm]	11.6" [294 mm]	4.3" [109 mm]	11.0" [279 mm]
BD-15	11.3" [287 mm]	16.3" [414 mm]	12.5" [318 mm]	4.8" [120 mm]	11.5" [290 mm]
BR-3A, BR-3ALZ	11.3" [287 mm]	17.8" [452 mm]	13.5" [343 mm]	Call factory for details	
BRTC-6	11.3" [287 mm]	19.1" [485 mm]	12.5" [318 mm]	Call factory for details	

Rack Mounted RC

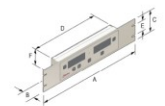

A	19.0" [483 mm]
B	1.8" [46 mm]
C	3.5" [89 mm]
D	11.2" [285 mm]
E	1.8" [45 mm]
F	3.1" [79 mm]



Safety

Safety Symbol

The symbols depicted below are safety symbols placed on spark test equipment. It is important to understand the meaning of each.



Caution symbol. Caution- refer to the manual to protect against damage to the equipment or to avoid personal injury.



Indicates Hot Surface. Do not touch.



Risk of electric shock symbol.



Earth ground symbol.

Environmental Conditions

The spark tester is designed to be safe under the following conditions:

- Indoor use.
- Altitude to 2000m.
- Temperatures from 5°C to 40°C.
- Humidity to 80% R.H. at 31°C, decreasing linearly to 50% R.H. at 40°C

The Clinton Instrument Company certifies that this equipment met its published specifications at the time of shipment. The calibrations of the equipment are checked against Measurement Standards (Reference) maintained by the Clinton Instrument Company. The accuracy of these standards is traceable to the national standards at the National Institute of Standards and Technology (NIST) or derived by ratio type measurements. For customer service or technical assistance with this equipment, please contact:

The Clinton Instrument Company
295 East Main Street, Clinton, CT 06413 USA
Telephone: 860-669-7548 Fax: 860-669-3825
Website: www.clintoninstrument.com
Email: support@clintoninstrument.com

Avoid the Risk of Fire!

Every time your wire line stops, be sure that the HV in the electrode goes off. If the HV remains ON while your wire line is stationary, the wire insulation within the electrode will heat and there is a danger of combustion. Refer to the table in "Installation" labelled "Terminal Block connections," under HV Enable on how to safely install your spark tester.

Caution: Pacemaker Warning

Clinton Instrument Company strongly advises any individual using a pacemaker or other such medical device to avoid operating or being in the vicinity of spark testers. Current studies indicate that such medical devices can malfunction in the presence of electrical and magnetic fields. When a fault occurs in the electrode of a Clinton spark tester, both high and low frequency electromagnetic fields are generated. The strengths of these emissions are unknown, since they depend on test voltage and other variables. The danger is greater when a customer does not ground the inner conductors of a test product. While Clinton cautions its customers to ground the test product for safety reasons, many times this warning is ignored. In this situation, both the spark tester and the entire length of the wire line will radiate these emissions. There is also a serious risk of electrical shock if an individual comes into contact with an ungrounded test product.

Email: support@clintoninstrument.com.

Electrical Shock Hazard from Production Line Spark Testers

By Henry H. Clinton

The commonly accepted maximum values of 60Hz. current passing through the human adult body which permit a subject to let go of electrodes are nine milliamperes for males and six milliamperes for females. At 3000 Hz. this value increases to about 22 milliamperes for men and 15 milliamperes for women, DC currents do not present the same let-go problems, but a subject can readily let go at a level of 60 milliamperes. A continuous 60 Hz. current above 18 milliamperes stops breathing for the duration of the shock only. Ventricular fibrillation may occur above a level of 67 milliamperes. The reaction current level of 60 Hz. is about .5 milliamperes. Above this level a muscular reaction can occur which can cause a secondary accident. The DC and 3 kHz. Levels are probably considerably higher. Capacitor discharge energy of 50 Joules (watt-seconds) is regarded as hazardous.

Clinton DC spark testers are current limited to 5 milliamperes or less. Three kilohertz spark testers are limited to 4 milliamperes or less, and 60 Hz. types to 7 milliamperes. Impulse spark testers can deliver a maximum charge of about .2 Joules 248 times per second. All these spark testers have current outputs above the reaction level, but none above the let-go threshold level. Because of the

possibility of secondary accidents caused by muscular reactions, operators should be protected against accidental shock. Electrodes are supplied with interlock switches, and these should not be disabled. The conductor under test should be grounded. If an operator must inspect the product by touching its surface while it is being spark tested, he should be electrically insulated from his environment, and any possible cause of a secondary accident caused by reaction should be eliminated.

For references, see: Dalziel, Ogden, Abbot, "Effect of Frequency on Let-Go Currents," Transactions of A.I.E.E., Volume 62, December 1943, and Dalziel, "Electric Shock Hazard," I.E.E.E., Spectrum, February 1972.

Installation

CAUTION:

The installation procedures listed below are to be performed by qualified service personnel only. Failure to follow these procedures may result in danger to personnel and equipment damage.

Unpacking

Remove the spark tester from the carton. Retain the packing material in the event that the unit is returned for calibration or service at some future time.

The following items are packed with the spark tester:

1. DC-B Spark tester
2. RC Display With mounting bracket (when ordered)
3. A power cord
4. A 9-Pin green terminal block connector for process control connections. After it is wired, it will plug into the terminal block on the back of the spark tester
5. A 4-Pin green terminal block connector for process control connections. After it is wired, it will plug into the terminal block on the back of the spark tester
6. RS-485 connecting cable 1 Foot Long
7. Quick Start Guide
8. Short Manual

Site Preparation

Select a suitable location for the spark tester:

The DC-B Spark Tester is designed for use in a fixed location, permanently connected to its power source. The unit may be mounted on a table or on a Clinton floor stand and should be placed at wire line height and within easy reach of the operator. For detailed dimensions of the spark tester, please see the specification sheet.

The spark tester should be adjusted so that the product runs centered in the electrode in both the vertical and horizontal axes and parallel to the mounting plate. Vertical and horizontal dimensions for wire centers for standard electrodes can be found on drawings supplied with this manual. For non-standard electrodes, or for copies of the required drawings, contact the Engineering Department of The Clinton Instrument Company.

When the spark tester is to be placed on a primary or jacketing (sheathing) extrusion line, it is desirable to locate the equipment as close to the extruder cross-head as practical, this generally means locating it just after the water cooling trough. In this case it is important to wipe the water off of the product thoroughly before it enters the spark tester electrode containment. Failure to adequately dry the surface of the wire or cable can cause false-counting, and can cause premature failure of the equipment.



To mount the unit on a horizontal surface:

With a screwdriver, remove the (4) plastic feet from the tapped inserts in the bottom of the spark tester chassis. Insert (4) M-6 screws through the mounting surface into the (4) tapped inserts. Be sure the screws do not extend into the chassis more than 1/2 inch (12mm).



To install the unit on a Clinton floor stand:

Assemble the floor stand as shown in the drawings at the back of this manual. Secure the tripod base of the floor stand to the shop floor using 1/2" (12mm) bolts and washers. Remove the (4) plastic feet from the tapped inserts on the bottom of the spark tester chassis, as shown above. Mount the spark tester to the stand by feeding (4) M-6 screws supplied with the floor stand through the bottom of the floor stand plate and into the (4) tapped inserts in the bottom of the spark tester.



To install RC Display onto the DC-B

With a screwdriver, remove the 2 Screws on the top of the DC-B. Align the 2 mounting holes on the RC display mounting bracket with the holes on the top of the DC-B. Secure the bracket with the 2 screws that were removed.

Once the display is secure to the top of the unit Connect the 9-pin Serial port on the rear of the RC display to the 9-pin “DISPLAY” port on the rear of the DC-B spark tester using the supplied 1 foot long serial cable.

The RC display can be mounted remotely up to 200 feet away using an optional serial cable. See Optional Accessories for part numbers.

Provide for ventilation of the Test Module

As with any apparatus producing a spark or electrical corona, the DC-B Spark Tester produces ozone in the electrode region. While ozone reverts harmlessly to oxygen within a few minutes, an external air extraction system is recommended and should operate whenever the spark tester is in use. The exhaust of the external air extraction system should be discharged either outdoors or into some area well away from workers.

Power Wiring

Install an external disconnecting device



Install an external switch or circuit breaker in close proximity to the spark tester and within easy reach of the operator. The switch or circuit breaker must meet the relevant requirements of IEC 947-1 and IEC 947-3 and should be marked as the disconnecting device for the equipment. The rating of the circuit breaker or fuse should be no greater than 5 amperes.

Caution: Be sure the external disconnecting device is OFF and locked out before continuing.

Mains Power

Note that the spark tester has a self-adjusting power supply with an operating voltage range of 100V to 240V at 49-61 Hz.

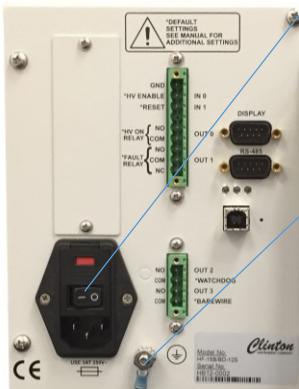

Ground the Spark Tester

Locate the ground stud on the back panel of the spark tester. Remove the outer nut and crimp terminal. Crimp a 16 awg. (1, 29 mm², 1, 31 cross section) stranded insulated wire (preferably green with a yellow stripe) to the crimp terminal. Fasten this to the ground stud and secure with the keps nut. Connect the other end to a safety ground system in accordance with EN 60204-1:1993, Section 5.2, Table 1.

Terminal Block Wiring



Refer to the following table for information on pin functions. Locate the green terminal blocks on the back of the spark tester and its companion green terminal block connectors that came with the unit.

Conductors connecting auxiliary equipment, relays and switches should be shielded 22 gauge or larger and should be stripped back $\frac{1}{4}$ " (6mm) and fed into the green terminal block connector at the proper pin number. Shields from conductors connecting auxiliary equipment should be grounded to the safety ground terminal.



9 - Pin Terminal Block Connections	Pin No.	Designation	Conductor
<p>HV Enable (IN0): CAUTION: For HV on the electrode, install a normally closed switch or relay contact** between pins 1&2. This switch or relay should open automatically when the wireline stop switch is activated or be opened manually by the system operator when the line stops. FAILURE TO DO SO COULD RESULT IN A FIRE HAZARD If the HV remains ON in the electrode when your line is stationary, the wire insulation in the electrode will heat and there is a danger of combustion.</p> <p>External Reset (IN1): To reset the spark tester fault relay with an external switch, wire a momentary switch** between pins 1&3. When these contacts close, the fault relay will return to a normal state. The interval that the contacts are closed must exceed 50 ms.</p>	1	GND	(3) 22 ga. stranded conductors rated 250V, less than 10 meters in length, contained in a common insulating sheath
	2	HV ENABLE	
	3	RESET	
	4	not used	
<p>HV ON Indication (OUT0): Dry relay contact pins 5&6 will close when the test voltage exceeds 500v. For an indication that HV is ON in the electrode, wire a lamp or auxiliary device* here.</p>	5	NO	(3) 22 ga. stranded conductors rated 250V, less than 10 meters in length, contained in a common insulating sheath
	6	COM	
<p>Process Control (OUT1): To activate external lights, alarms or relays* when a fault occurs, wire them between dry relay contact pins 9,8 & 7. If the output function is set to LCH or RVF the dry relay contacts will remain closed until the RESET button is pressed or when pins 1&3 are closed by remote switch or relay. If the output function is set to NLC, the dry relay contacts will return to normal state after the interval known as the AMFS (Any Fault Alarm Time) has elapsed.</p>	7	NO	
	8	COM	
	9	NC	
<p>* When connecting auxiliary equipment to dry relay contact pins 5, 6, 7, 8 or 9, observe maximum ratings of 120VAC at 2 amps, 240VAC at 1 amp. **Switches and relays connected to pins 1,2, & 3 should be suitable for 24V low current applications.</p>			
4 - Pin Terminal Block Connections	Pin No.	Designation	Conductor
<p>Watch Dog (OUT2): Dry relay contact pins 1&2 will close when the test voltage is between the VWDL (Voltage Watchdog Low Threshold) and the VWDH (Voltage Watchdog High Threshold) values.</p>	1	NO	(3) 22 ga. stranded conductors rated 250V, less than 10 meters in length, contained in a common insulating sheath
	2	COM	
<p>Bare Wire (OUT3): To activate external lights, alarms or relays* when a Bare Wire type fault occurs, wire them between dry relay contact pins 3 & 4. If the output function is set LCH or RVF, the dry relay contacts will remain closed until the RESET button is pressed or when pins 1&3 are closed by remote switch or relay output function is set to NLC, the dry relay contacts will return to normal state after the interval known as the ABMS (Any Bare Wire Alarm Time) has elapsed.</p>	3	NO	
	4	COM	
<p>*When connecting auxiliary equipment to dry relay contact pins 1, 2, 3, or 4, observe maximum ratings of 120VAC at 2 amps, 240VAC at 1 amp.</p>			

Connecting the Serial RS-485



The model DC-B is equipped with an RS-485 serial interface allowing the spark tester to receive commands and exchange information with a PLC or computer. Programming and control of voltage settings, which can be done manually on the DC-B display, can also be done through this interface. Control display buttons can be disabled when the serial interface is in use. See the section entitled "[RS-485 Interface](#)" for connection and communication information.

The "RS-485" interface connector is located on the rear of the DC-B directly under the "Display" connector.

Connecting to the Analog Interface (Optional)



The model DC-B can be purchased with an optional analog interface. (Model DC-BA) The analog interface allows the DC-B to be controlled by a PLC with standard analog and Digital I/O. The connecting cable for this interface is not supplied by Clinton Instrument Company. The cable composition is normally dictated by the PLC, but ordinarily 22 gauge conductors (individually shielded or shielded pairs) are required. The maximum length of the cable is also determined by the equipment the DC-B is being connected to. However, it is recommended that the cable length not exceed 10 meters.

See the section entitled "[Analog Interface](#)" for the details regarding this interface.

Installing the CompactCom™ Module (Optional)



The model DC-B can be purchased with an optional Fieldbus Communications Interface. (Model DC-BX) This interface will allow the installation of several fieldbus options. (DeviceNet, Ethernet IP, Modbus TCP, Profibus, Profinet)

To enable the Fieldbus Interface the proper CompactCom™ module will need to be installed into the DC-BX spark tester.

- First remove the Anybus Slot Cover from the rear of the spark tester.
- Remove the CompactCom™ module from the packaging.
- Slide the CompactCom™ module into the open slot on the rear of the spark tester.
- Secure the CompactCom™ module by tightening the 2 screws.

See the section entitled "[Fieldbus Interface](#)" for the details regarding this interface.



Connecting the X3B (Optional)



Unpacking the X3B

Remove the following items from the carton:

1. X3B Horn/Light Tower with mounting plate. Note: If the X3B was ordered for the BD-22 electrode, the carton should contain the BD-22 mounting plate (part #91243).
2. Power Cord (part #03780)
3. A 4 conductor cable, with a 9-pin terminal block connector on one end and a 10-pin connector on the other. (part #91247)



Connecting the X3B



1. Decide which side of the spark tester you wish to mount the X3B. Note that you may have to remove the small plate from the X3B chassis and secure it to the opposite side so that the green X3B terminal block is accessible from the spark tester back panel. Mount the X3B using the mounting plate and the (4) bolts that attach the end guard to the spark tester, as shown in the picture to the left.
2. Make sure the spark tester is off before wiring to the X3B.
3. Locate the 10-pin green terminal block on the back of the X3B and the 9-pin terminal block on the back of the spark tester. The X3B is supplied with a 4 conductor cable. The 10-pin connector will plug into the X3B terminal block and the 9-pin connector will connect to the spark tester terminal block. Prior to inserting them, pins 1-5 of the 10-pin connector should be wired to accessory equipment with 22 gauge or larger, stripped back 1/4" (6mm) and fed into the green terminal block connector at the proper pin numbers, as described on the following page. Pins 1-3 of the 9-pin connector should be wired as described on the following page.
4. When wiring the two units, notice that pins 5-8 on the spark tester are now being used to communicate with the X3B. The functions of pins 5-8 on the spark tester have now been transferred to pins 1-5 on the X3B terminal block. When the wiring is complete, plug in the power cords to both X3B and the spark tester.

X3B to Spark Tester Connections

X3B Horn/Light Tower Terminal Block Connections				Spark Tester Terminal Block Connections					
Conductor	Designation		Terminal Block Connections	Pin No.	Pin No.	Terminal Block Connections	Designation		Conductor
4-Conductor Cable Supplied with X3B (22 gauge or higher)	Fault Relay	COM	To Spark Tester: Wire pins 10-7 to spark tester pins 8-5 on the spark tester terminal block connector	10		9	Not Used	NC	4-conductor cable supplied with X3A (22 gauge or higher)
		NO		9		8			
	HV ON Relay	COM		8		7	NO		
		NO		7		6		COM	
Not Used				6	5	HV ON Relay (OUT0)	COM		NO
(3) 22 ga. stranded conductors rated 250V, less than 10 meters in length, contained in a common insulating sheath	Fault Relay	NC	Process Control: To activate external lights,alarms or relays* when a fault occurs, wire them between dry relay contact pins 5,4 & 3. If the Lch function is ON (set on the front panel), the dry relay contacts will remain closed until the RESET button is pressed or when pins 1&3 are closed by remote switch or relay. If the Lch function is OFF, the dry relay contacts will return to normal state after the interval known as the PCd (Process Control Duration, set on the front panel) has elapsed.	5	4		Not Used		
		COM		4	3	External Reset: To reset the spark tester fault relay with an external switch, wire a momentary switch** between pins 1&3. When these contacts close, the fault relay will return to a normal state. The interval that the contacts are closed must exceed 50 ms. HV Enable: CAUTION For HV on the electrode, install a normally closed switch or relay contact** between pins 1&2. This switch or relay should open automatically when the wireline stop switch is activated or be opened manually by the system operator when the line stops. FAILURE TO DO SO COULD RESULT IN A FIRE HAZARD If the HV remains ON in the electrode when your line is stationary, the wire insulation in the electrode will heat and there is a danger of combustion.	RESET		
		NO		3	2			HV ENABLE	
22 ga. stranded conductors rated 250V, less than 10 meters in length, contained in a common insulating sheath	HV ON Relay	COM	HV ON Indication: Dry relay contact pins 1&2 will close when the test voltage exceeds 500v. For an indication that HV is ON in the electrode, wire a lamp or auxiliary device* here.	2	1	1	GND		
		NO		1					
*When connecting auxiliary equipment to dry relay contacts pins 1, 2, 3, 4, or 5, observe maximum ratings of 120VAC at 2 amps or 240VAC at 1 amp.				**Switches and relays connected to pins 1,2, & 3 should be suitable for 24V low current applications.					

Spark Tester Controls



ON/OFF Power Switch

This switch is located on the rear panel of the spark tester.



Voltmeter

The voltmeter will indicate the high voltage present at the electrode. The voltage is displayed in kV. When the output is set to 1,000V the display will read 1.0. A reading of 10.2 indicates that the test voltage at the electrode is 10.2kV DC.

This display can also display a "Percent Load" value and the "Set Point" value by pressing the "A" Button. These values will be displayed momentarily on the Voltmeter display and then will return to displaying the spark tester voltage at the electrode.

"A" Button

Pressing the "A" button will momentarily cycle the Voltage display through the "Percent Load" and the "Set Point" Values.

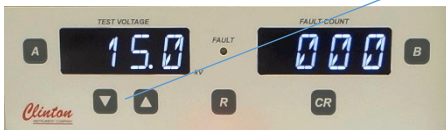

UP/DOWN ARROW (VOLTAGE ADJUST) buttons

The spark test voltage may be adjusted from 0 to the maximum voltage (1,000 for the DC-1B, 10,000 for the DC-10B and 20,000 for the DC-20B) in 100 volt increments by pressing the up and down arrow buttons under the voltmeter. Press and hold a button to increase the speed at which you change the voltage setting.



Fault Counter

The 3-digit fault counter registers a count each time any fault type is detected in the electrode. This display can also momentarily show 4 additional fault counts by pressing the "B" button. These fault counts are Pinhole, Metal Contact, Multiple pinhole, Gross Bare wire. Press the CR button to reset the number of faults on the counter to 0.

"B" Button

Pressing the "B" button will momentarily cycle through the 4 additional fault count values. (Pinhole, Metal Contact, Multiple Pinhole, Gross Bare Wire)

"CR" COUNT RESET button

Pressing the "CR" button will reset all fault count values.

FAULT light

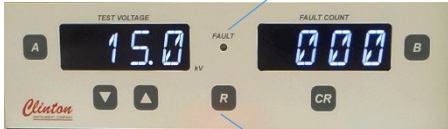

The FAULT light will illuminate in response to any fault condition and will mirror the Any Fault Alarm. It also indicates that the Any Fault Alarm relay contacts are in fault condition, activating any accessories that are connected. If the Any Fault Alarm output function is configured to the LCH mode the fault light will remain on, otherwise the FAULT light will turn off automatically. The FAULT light can be turned off in 3 ways: (1) by pressing the “R” button below it; or (2) by closing a momentary switch or relay contacts wired between Pins 1 & 3 of 9-Pin green panel terminal block on the rear panel; (3) though one of the serial communication interfaces.

“R” RESET button

Pressing the “R” button will reset all fault conditions and their corresponding Relay output. The RESET button will have no effect on the number of faults registered on the fault counter.

High Voltage On Lamp

The high voltage On Lamp will turn on when the high voltage output level is above 500V.



Bead Chain Electrode

When the spark tester power is ON and the clear protective cover is down, the test voltage set on the spark tester front panel is applied to the product under test as it runs through the electrode. 1”, 2”, and 3” bead chain electrodes are available. Other electrodes are available. Please contact factory for details.

Clear Protective Cover

The clear cover protects the operator from coming into contact with the energized electrode.

Safety Interlock switch

This switch turns OFF the high voltage in the electrode when the clear protective cover is lifted. Do not attempt to defeat the safety interlock switch.

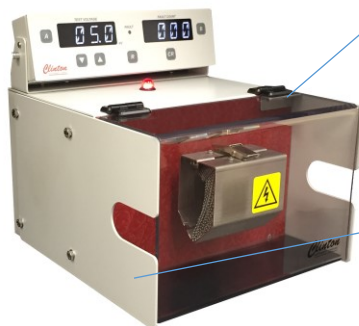

Safety end guards

Metal end guards on each end of the high voltage test module prevent the operator from reaching into the energized electrode. The test product should be centered in the electrode to avoid damage to the product.

Definition of Terms

Actual Voltage- Actual voltage is a metering winding on the high voltage transformer. This winding can be monitored remotely and indicates the level of voltage supplied to the electrode.

Any Fault Alarm- This alarm will respond when a fault of any type is detected. This alarm can be latched, and when latched the voltage can be removed or left on. When the alarm is not latched, the duration of this alarm is selectable. (See Latch, Non-Latch, & Remove Voltage on Fault, below).

Electrode Voltage- This is a new feature, exclusive to Clinton's DC-B spark tester, a separate circuit makes a direct connection to the spark tester electrode. The voltage is monitored by a high impedance sensing circuit providing immediate data about the voltage at the electrode. This data is crucial to differentiate the different fault types.

Fault Pulse- The fault pulse is a signal generated by the DC-B when a defect is detected. This signal causes the front panel fault lamp to light, increments the fault counter, and initiates process control relays to change state. In general, the fault pulse must last at least as long as the fault stays in the electrode, in order for a single fault to be counted only one time.

Fault Sensitivity- Fault sensitivity refers to the amount of current that must pass through a pinhole or other defect type to be detected as a defect and typed accordingly.

“NOR”: The Normal Sensitivity setting is Clinton Instrument Company's bench standard and will pass the IEC 62230 600 μ A standard for spark tester sensitivity.

“RED”: The Reduced Sensitivity setting will meet the NEMA WC 56 standard for spark tester sensitivity and will meet the IEC 62230 reduced sensitivity (1.2 mA) standard used when high product capacitance causes false or phantom counting. For more information, contact the Clinton Instrument Company at support@clintoninstrument.com

Gross Barewire- Gross Barewire is defined as a fault where the wire conductor is exposed, allowing metal contact to be made with the electrode for a period of time equal to two and one half times the electrode length.

High Voltage Enable- In order for the DC-B to generate high voltage, the HV-ENABLE terminal must be connected to the GROUND terminal on the terminal block. This can be by direct wire jumper at the terminal block (pins 1 and 2) or the connection can be made remotely by switches or control relays.

Latch, Non-Latch, & Remove Voltage on Fault- These are the conditions under which the fault relay operates when a fault is detected.

Latch- When a fault is detected the fault relay will change state and remain in that state until a reset command is given, either by pressing the front panel reset button, connecting the RESET and GND terminals on the terminal block, or providing a remote reset command through the Compact Comm modules. High Voltage remains ON while the relay is latched.

Non-Latch- When a fault is detected, the fault relay will change state only for the amount of time the fault remains in the electrode. This time can be extended by changing the Process Control Duration Time.

Remove Voltage on Fault- When the unit is in LATCH mode and a fault is detected, the relay will latch. When Remove Voltage on Fault is selected, high voltage will be disabled while the relay is latched, so the wire may be safely handled or inspected. When the system is reset either by pressing the front panel reset button, connecting the RESET and GND terminals on the terminal block, or providing a remote reset command through the Compact Comm modules, the system will be reset and high voltage will be restored. **Remove Voltage on Fault** has no effect when the unit is in **Non-Latch** mode

Metal Contact- Sometimes referred to as BARE WIRE. A Metal Contact fault is defined as a defect or bare patch in the insulation that allows the electrode to come into momentary direct contact with the wire conductor. In order for a fault to be typed as a metal contact, the bead chain electrode must make physical contact with the conductor under test.

Multi-Pinhole- A Multi-Pinhole is defined as two or more pinhole faults closely spaced. It can also be a single fault of longer duration where no metal contact was made between the wire conductor and the electrode.

Pinhole- A pinhole is defined as a short-duration fault where no direct metal contact between the wire conductor and the electrode is made.

Set Point Voltage- This is the desired test voltage that is input through the front panel controls or remotely by PLC

Voltage Watchdog- Test Voltage parameters may be set by users to ensure that adequate test voltages are always being used to test product. These values can be based off of upper/lower limits (WDL), or percentage of set point voltage (EVP).

New Features

Display: The DC-B is available with a bright, detachable display, (Model RC). This display connects to the test module with a short serial cable and eliminates the need for a separate remote display (like our previous model ARC, used with the DC-xxA). The RC display can be mounted up to 60 meters (200 feet) away with a longer, shielded, serial cable. If the customer wants to mount the RC display remotely in a rack mount instrument panel, a rack-mount adaptor is available, (CIC Part No. 92244).

Front Panel Security: The DC-B system offers a customizable password protect option that can be enabled, if desired, to prevent operators from changing or accessing information. There are four levels of password protection that allow supervisors to choose exactly what the operators are able to access.

BD-12S Design (Patent Pending): The new split-electrode design provides an easy way to string up a cable through the bead chain electrode, guaranteeing precise center placement for the most effective and reliable test. The bead chains are now arranged at an angle, eliminating gaps between hanging beads, and providing the best coverage around the product at all times.

Communication Modules: The DC-B supports Modbus RTU via the RS-485 port. An optional PCB may be added to the DC-B for easy communication to most PLCs. This PCB can be factory installed or added later. Analog, DeviceNET, Ethernet/IP Profibus, Profinet, and Modbus TCP protocols are all available options. Communication protocols can easily be changed at any time with the purchase of an upgrade kit or a new plug-in module.

Voltage Watchdog: Test voltage parameters can be set by users to ensure adequate test voltages are always being used to test product. For example, if the spark tester should be continuously testing at 4kV, users can set the system to alarm if the spark tester voltage were to fall below 3kV or rise above 5kV. Preset upper and lower voltage limits may be set using the front panel or remotely.

Redundant Voltage Monitoring: In addition to standard voltage monitoring, the DC-B monitors the voltage at the electrode to verify correct voltages are being maintained.

Four output relays: One set of form C and three sets of form A relay contacts are located on the back of the DC-B for easy connection to external alarms, lights, or machinery that will be controlled by the spark tester. Relay functions can be selected from options including: High Voltage ON indication, Fault Alarm, All Bare Wire Alarm (this includes both Direct metal contact and gross bare wire conditions), and Voltage Watchdog.

Fault Typing: Detecting the flow of current during spark testing has always been the standard in spark testing. The DC-B revolutionizes the concept of fault detection by the use of DSP Based Fault Typing. We can now differentiate 4 types of fault conditions: Pinhole, direct metal contact, multi-pinhole, and gross bare wire.

Definitions of fault conditions:

- **Pinhole-** A pinhole is defined as a short-duration fault where no direct metal contact between the wire conductor and the electrode is made.
- **Multi-Pinhole-** A Multi-Pinhole is defined as two or more pinhole faults closely spaced. It can also be a single fault of longer duration where no metal contact was made between the wire conductor and the electrode.
- **Metal Contact-** Sometimes referred to as BARE WIRE. A Metal Contact fault is defined as a defect or bare patch in the insulation that allows the electrode to come into momentary direct contact with the wire conductor. In order for a fault to be typed as a metal contact, the bead chain electrode must make physical contact with the conductor under test.
- **Gross Barewire-** Gross Barewire is defined as a fault where the wire conductor is exposed, allowing metal contact to be made with the electrode for a period of time equal to two and one half times the electrode length.

Backwards Compatible: All that is needed for a customer to upgrade from the DC-A series to the DC-B series is to unplug the power cord and the 9-pin green terminal strip from the back panel on the DC-A and to plug it into the DC-B. The DC-B will function identically to the DC-A if the user does not wish to use any of the additional features. The bolt patterns on the bottom of the DC-B are the same as the DC-A for easy physical replacement.

Automatic Calibration with STCAL System: When calibrating with Clinton Model ST-CAL, there is no need to open the equipment, or to make any physical adjustments during the process. The DC-B will communicate with a Tablet and Voltmeter to make all necessary adjustments. Calibration results, Serial information, and other optional information is provided on a Calibration Certificate which can either be printed to a network printer or exported to a USB stick to keep for future records.

Universal Power Supply: Will work on 100/120, 200/240 input voltage without internal rewiring.

Percent Load Meter: By toggling the A button on the control panel, the voltage will change from volts to percent of current output being used to produce the test voltage in real time

Fault output options: remove voltage on fault for Alarm Modes

Spark Tester Configuration (Front Panel)

Navigating the Configuration Menu

This section will explain how to navigate and configure the unit from the configuration menu using an RC Display.

Entering configuration: While the RC Display is in normal run mode, hold the “Down Button & CR Button” for approximately four seconds. The system will enter configuration mode and voltage output will be disabled. If the display has been locked by a PIN, a PIN entry screen will be presented. For more information see “RC Display Security” below.

“A” Button: If pressed while at a top level menu item it will exit configuration. If pressed while inside a submenu, it will return to the top level menu item.

“B” Button: If pressed it will enter the sub menu of the currently selected menu item.

“CR” Button: Used to change settings in a sub menu. Pressing the CR button once will enable edit mode and display . Use “up and down” arrows to toggle between sub menu options. Pressing the CR again will remove the * and save the changed selection.

RC Display Security (PIN)

To Lock / Unlock the RC Display manually, hold the A & B Buttons for at least four seconds.

If the display is locked it will require entry of the PIN number before it will unlock. The factory default PIN code is 111.

If the display is unlocked, the display will lock to the “**PLM**” mode that is set in the configuration menu. For more information see “Configuration Menu Options” below.

Configuration Menu Options

OUT0 -- **XXX**

This configures the “Output Function” assigned to the hardware output labeled “OUT0”, XXX is the configured function. For sub menu items, see the “Spark Tester Outputs” section of this manual.

OUT1 -- **XXX**

This configures the “Output Function” assigned to the hardware output labeled “OUT1”, XXX is the configured function. For sub menu items, see the “Spark Tester Outputs” section of this manual.

OUT2 -- **XXX**

This configures the “Output Function” assigned to the hardware output labeled “OUT2”, XXX is the configured function. For sub menu items, see the “Spark Tester Outputs” section of this manual.

OUT3 -- **XXX**

This configures the “Output Function” assigned to the hardware output labeled “OUT3”, XXX is the configured function. For sub menu items, see the “Spark Tester Outputs” section of this manual.

IN0 -- **HVE**

This displays that the High Voltage Enable “HVE” is assigned to the hardware input labeled “IN0”. This input is not re-assignable.

IN1 -- **FR**

This displays that the Fault Reset “FR” is assigned to the hardware input labeled “IN1”. This input is not re-assignable.

PIN -- **CON** Menu Option FW up to b0119

Or

RC -- **CON** Menu Option FW b0120 and up

This is the password (PIN) configuration menu. For sub menu items press B.

EXLM -- **XXX**

PIN protect External Remote Enable active: Function Available on FW version b0120 and up. (Units shipped after 5/3/23)

Green - shows items available when unit is in External Remote
 Red - shows items Not available when unit is in External Remote

	EXLM = 0	EXLM = 1	EXLM = 2	EXLM = 3	EXLM = 4
Config Menu	Green	Red	Red	Red	Red
Voltage Adjust	Green	Green	Red	Red	Red
Count Reset	Green	Green	Green	Red	Red
Fault Reset	Green	Green	Green	Green	Red

PPU -- **XXX**

PIN protect RC Display on power up:

When “Yes”, the unit will be locked in the mode defined by “PLM”.
 When “No”, the unit will not be locked on power up.

PLM -- **XXX**

PIN lock mode: This can be set to “0”, “1”, “2”, or “3”.

When the unit is locked, the different modes will lockout the following functions on the RC Display.

“0”: Configuration Menu Access.

“1”: Configuration Menu Access, Voltage Adjust.

“2”: Configuration Menu Access, Voltage Adjust, CR Button.

“3”: Configuration Menu Access, Voltage Adjust, CR Button, R Button.

PIN -- **XXX**

This is where the PIN number is displayed and can be modified. The factory default PIN code is 111.

VOLT -- **CON**

This configures the voltage parameters for the unit.

VLIM -- **AUT**

This configures the unit's maximum voltage with 1 decimal place. If more precision is needed, use FADJ. The setting of AUT will allow the maximum the unit will produce.

"AUT": Automatic maximum voltage

"xx.x": The value of the new limit

FADJ -- **AUT**

This configures the unit's maximum voltage using VLIM as a starting point to allow 2 decimal places. The setting of AUT will allow the maximum the unit will produce.

"AUT": Automatic maximum voltage

"x.xx": The value of the new limit

VSEL -- **AV**

This configures which voltage to monitor when limiting the voltage. use when the unit's maximum voltage using VLIM as a starting point to allow 2 decimal places. The setting of AUT will allow the maximum the unit will produce.

"AV": Actual voltage as read from the high voltage power supply

"EV": Electrode voltage as read from the electrode

DBEN -- **NO**

This configures the use of the discharge bar output. When enabled the output will turn on when the voltage is set above 0.

When "Yes", the output will be used.

When "No", the output will remain inactive.

DBMS -- **XXX**

This delay used when voltage is called for till the voltage is output. This is in seconds.

F3 -- **CON**

This configures the settings associated with fault detection for the unit.

FSMO -- **TS0**

This configures the unit's fault sensitivity mode. See Fault Sensitivity in the "Definition of Terms" section of the manual for more information. The values range from TS0 (normal sensitivity) to TS4 (maximum reduced sensitivity)

ELE -- **XXX**

It is recommended that this be configured to the electrode length in inches.

FP -- **XXX**

The Fault Pulse "FP" time of the unit may be set to Auto "AUT" or set to a numeric value. See Fault Pulse Length in the "Definition of Terms" section of the manual for more information.

"AUT": Auto mode uses default information to calculate a fault pulse.

LS -- **XXX**

The Line Speed "LS" time of the unit may be set to Auto "AUT" or set to a numeric value in **feet per minute**. See Fault Pulse Length in the "Definition of Terms" section of the manual for more information.

"AUT": Auto mode uses the maximum line speed possible for the configured electrode length in fault pulse calculation (EX. 2 Inch Electrode = 3333 Feet per minute).

FR -- **XXX**

The Fault Resolution "FR" may be set to Auto "AUT" or set to a numeric value in inches between faults.

"AUT": Auto mode uses default information to calculate a fault pulse.

The "FR" setting will affect how different types of faults are categorized. See the "New Features" section of this manual for more information on Fault Typing.

FLT 1 -- **XXX**

Fault Filtering Mode. This mode is to prevent specific false counting problems. Consult the Factory for details at support@clintoninstrument.com

"ON" Filter is Enabled

"OFF" Filter is Disabled

E485 -- **CON**

Configures the External RS-485 Modbus Communications port. Changes will not take effect until the system is restarted.

MAJR -- **XXX**

This configures the RS-485 Modbus Slave Address, where “XXX” is the slave address.

BAUD -- **XXX**

Configures the unit’s RS-485 Baud Rate, where “XXX” is the Baud Rate in bps.

ABCC -- **XXX**

Function Available on units with FW version b0120 and up. (Units shipped after 4/1/23)

Turn this function “ON” to enable support for the 92664 CompactCom Communication PCB Assembly.

Turn this Function “OFF” if there is no CompactCom Communication PCB Assembly installed in the unit.

For Non-IP based Fieldbus, the following Node address menu will be displayed.

NAJR -- **XXX**

Node address for non-IP based networks. (Will only be displayed if applicable)

For IP based Fieldbus the following menu items will be displayed.

DHCP -- **XXX**

Sets the DHCP mode “ON” or “OFF”. The default state is “OFF”

IP0 -- **XXX**

IP Address (1—255), Default (10) Ex. 10.10.10.101

IP1 -- **XXX**

IP Address (1—255), Default (10) Ex. 10.10.10.101

IP2 -- **XXX**

IP Address (1—255), Default (10) Ex. 10.10.10.101

IP3 -- **XXX**

IP Address (1—255), Default (10) Ex. 10.10.10.101

SUB0 -- **XXX**

Subnet Mask (1—255), Default (10) Ex. 10.10.10.101

SUB1 -- XXX

Subnet Mask (1—255), Default (10) Ex. 10.10.10.101

SUB2 -- XXX

Subnet Mask (1—255), Default (10) Ex. 10.10.10.101

SUB3 -- XXX

Subnet Mask (1—255), Default (10) Ex. 10.10.10.101

GW0 -- XXX

Gateway (1—255), Default (10) Ex. 0.0.0.0

GW1 -- XXX

Gateway (1—255), Default (10) Ex. 0.0.0.0

GW2 -- XXX

Gateway (1—255), Default (10) Ex. 0.0.0.0

GW3 -- XXX

Gateway (1—255), Default (10) Ex. 0.0.0.0

LCFG -- XXX

This displays the local configuration option.

“ON” : When “ON” the IP Settings or Node Address used in the CompactCOM communication module will be loaded from the Spark tester on power up.

“OFF” : When “OFF” the CompactCOM communication module will use the IP Settings or Node Address last stored in the CompactCom module.

FW -- INF

This displays the current firmware version for the TST-10B and the RC. This information will be useful when contacting Clinton Instrument Company for technical support.

FWTY -- XXX

Press the “B” Button once to display the DC-xxB firmware version number.

TMDD -- XXX

Press the “Down” Button once to display the DC-xxB firmware build number.

TMBC -- **XXX**

Press the “Down” Button once to display the TS DC-xxB TB firmware Build Code. (Spark Tester ST)

TMBR -- **XXX**

Press the “Down” Button again to display the DC-xxB Display firmware build revision.

RCBB -- **XXX**

Press the “Down” Button once to display the RC firmware build number.

RCBC -- **XXX**

Press the “Down” Button again to display the RC firmware Build Code. (Spark Tester ST)

RCBR -- **XXX**

Press the “Down” Button again to display the RC Display firmware build revision.

VMAX -- **XXX**

Press the “Down” Button again to display the maximum output voltage.

WMAX -- **XXX**

Press the “Down” Button again to display the maximum output power.

CAL -- **DATE**

Displays the last **factory** calibration date when the “B” button is pressed. (MM.DD YYYY)

Factory calibrations are valid for a period of one year.

CAL -- **DUE**

When B is pressed, the calibration due date will be displayed in the following format: “MM.DD” “YYYY”.

Note: The CAL DUE date is based on the CAL DATE value.

MCAL -- **HOLD**

When B is held for no less than 5 seconds a progress bar will be displayed and the unit will enter Manual Calibration mode. For more information, see the “Manual Calibration” Section of this manual.



When B is held for no less than 5 seconds a progress bar will be displayed and factory defaults will be reset in the unit.

Spark Tester Inputs

Input functions are assigned to input pins labeled IN0 and IN1 located on the terminal block, so that the unit will perform the required task.



High Voltage Enable (HVE)

To enable high voltage, install a wire jumper, normally closed switch, or relay between pins 1 & 2.

See the 9-Pin Terminal Block Connections table in the Terminal Block Wiring section of this manual for more information.



Fault Reset (FR)

To reset the spark tester fault relay with an external switch or relay, wire a momentary switch between pins 1 & 3. When these contacts close, the fault relay will return to a normal state. The interval that the contacts are closed must exceed 50 ms.

Spark Tester Outputs

Output Functions are designed to relay information to an alarm, PLC, etc. The Output functions can be assigned to output pins labeled 'OUT 0, OUT 1, OUT 2, and OUT 3.

General Outputs



Output Disabled (OFF)

This output will not do anything, under any condition.



Cover Open (CVO):

This output will change state when the safety interlock cover is open. If the safety interlock cover is closed, the spark tester is able to produce high voltage.



System OK (SOK)

This output will change state when there is a hardware malfunction that could cause the unit to operate outside of acceptable limits.

DIS**Discharge Bar (DIS)**

This output is the discharge bar output. When enabled, it will be activated when the voltage is enabled, and the voltage setting is above 0 and disabled when the voltage is set to 0 or the voltage is disabled.

HVE**High Voltage Enable (HVE)**

This output will change state when the unit meets all conditions to generate high voltage.

Voltage Monitor Output Options

HVL**High Voltage On Lamp (HVL)**

This output will change state when the actual voltage is equal to or above the set “**HVON**” configuration item value, and will turn off when the voltage is equal to or below the set “**HVOF**” configuration item value.

HVON**– High Voltage On (HVON)**

Set in kV. If the actual voltage goes above this set point, any “**HVL**” output will change state.

HVOF**– High Voltage Off (HVOF)**

Set in kV. If the actual voltage drops below this set point, any “**HVL**” output will change state.

Note – It is recommended that “**HVOF**” and “**HVON**” differ by at least .2kV and that “**HVOF**” never be set higher than “**HVON**”.

WDL**High Voltage Watchdog (WDL)**

The WDL output will change state when the actual voltage being produced (displayed) is between the set “**VWDL**” and “**VWDH**” limit values.

VWDL**– Voltage Watchdog Low Limit. Set in kV. (VWDL)****VWDH****– Voltage Watchdog High Limit. Set in kV. (VWDH)**

Note – It is recommended that “**VWDL**” and “**VWDH**” differ by at least 1kV and that “**VWDL**” is never set above the “**VWDH**” limit value.

For more information on the Voltage Watchdog, see the “New Features” section of this manual.

EVPElectrode Voltage Percent Based Watchdog (EVP)

The EVP output will change state when the electrode voltage monitor is within plus or minus the configured “EVWP” percentage of the set voltage. Example: Set point is 10kV, “EVWP” is 10%. If the electrode voltage is between 9kV and 11kV the output will signal.

EVWP– Electrode Voltage Watchdog Percent (EVWP)

Set as a percentage.

For more information on the Voltage Watchdog, see the “New Features” section of this manual.

AVPActual Voltage Percent Based Watchdog (AVP)

This output will change state when the main output voltage monitor is within plus or minus the configured “AVWP” percentage of the set voltage. Example: Set point is 10kV, “AVWP” is 10%. If the actual voltage is between 9kV and 11kV the output will be high.

AVWPActual Voltage Watchdog Percent (AVWP)

Set as a percentage.

For more information on the Voltage Watchdog or Actual Voltage vs Electrode Voltage, see the “Definition of Terms” section of this manual.

PLLPercent Load Limit (PLL)

This output will change state when the percent load reaches or exceeds the Percent Load Limit PLLT. **See the “Definition of Terms” section of the manual for more information.**

PLLTPercent Load Limit Threshold (PLLT)

Set as a percentage of the maximum current.

Fault Output Options

FPLFault Pulse (FPL)

This output will change state when a fault occurs. **See the “Definition of Terms” section of the manual for more information.**

When fault pulse times are shorter than 50mS, timings may not be exact when using relay type outputs.

AFAAny Fault Alarm (AFA)

This output will operate in 3 different modes, “NLC”, “LCH”, “RVF”. The Any Fault alarm is triggered by any high voltage fault that occurs. **See the “Definition of Terms” section of the manual for more information.**

AFMOAny Fault Alarm Mode (AFMO)**NLC**

– Non Latch Mode (NLC)

The output will change state for the configured “AFMS” time.

LCH

– Latch Mode (LCH)

The output will change state until it is reset at the front panel or remotely.

RVF

– Remove Voltage on Fault (RVF)

The output will change state and the test voltage will be disabled until it is reset at the front panel or remotely.

AFMSAny Fault Alarm Time (AFMS)

Set in seconds (.01 – 5.0). If “AFMO” is set to “NLC”, this is the time for which the output will change state.

PHAPinhole Alarm (PHA)

This output will operate in 2 different modes, “NLC”, “LCH”. The Pinhole alarm will respond only to a ‘Pinhole’ fault type. **See the “New Features” section of the manual for more information on fault typing.**

PHMOPinhole Alarm Mode (PHMO)**NLC**

– Non Latch Mode (NLC)

The output will change state for the configured “PHMS” time.

LCH

– Latch Mode (LCH)

The output will change state until it is reset at the front panel or remotely.

PHMSPinhole Alarm Time (PHMS)

Set in seconds (.01 – 5.0). If “PHMO” is set to “NLC”, this is the time for which the output will change state.

MCAMetal Contact Alarm (MCA)

This output will operate in 2 different modes, **"NLC"**, **"LCH"**. The Metal Contact alarm will respond only to a 'direct metal contact' fault type. See the "Fault Typing" section of the manual for more information.

MCMOMetal Contact Alarm Mode (MCMO)**NLC**

– Non Latch Mode (NLC)

The output will change state for the configured "MCMS" time.

LCH

– Latch Mode (LCH)

The output will change state until it is reset at the front panel or remotely.

MCMSMetal Contact Alarm Time (MCMS)

Set in seconds (.01 – 5.0). If "MCMO" is set to "NLC", this is the time for which the output will change state.

MPAMulti Pinhole Alarm (MPA)

This output will operate in 2 different modes, **"NLC"**, **"LCH"**. The Multi Pinhole alarm will respond only to a 'Multi Pinhole' fault type. See the "Fault Typing" section of the manual for more information.

MPMOMulti Pinhole Alarm Mode (MPMO)**NLC**

– Non Latch Mode (NLC)

The output will change state for the configured "MPMS" time.

LCH

– Latch Mode (LCH)

The output will change state until it is reset at the front panel or remotely.

MPMSMulti Pinhole Alarm Time (MPMS)

Set in seconds (.01 – 5.0). If "MPMO" is set to "NLC", this is the time for which the output will change state.

GBAGross Barewire Alarm (GBA)

This output will operate in 2 different modes, **"NLC"**, **"LCH"**. The Gross Barewire alarm will respond only to a 'Gross Barewire' fault type. See the "Fault Typing" section of the manual for more information.

GBMOGross Barewire Alarm Mode (GBMO)

NLC

– Non Latch Mode (NLC)

The output will change state for the configured “GBMS” time.

LCH

– Latch Mode (LCH)

The output will change state until it is reset at the front panel or remotely.

GBMSGross Barewire Alarm Time (GBMS)

Set in seconds (.01 – 5.0). If “GBMO” is set to “NLC”, this is the time for which the output will change state.

AFLAny Fault Limit (AFL)

This output will change state when the “Any Fault” Count is equal to or greater than the configured “**AFLT**”.

AFLTAny Fault Count Limit (AFLT)

Amount of counts allowed before the output responds.

PHLPinhole Limit (PHL)

This output will change state when the “Pinhole” count is equal to or greater than the configured “**PHLT**”.

PHLTPinhole Count Limit (PHLT)

Amount of counts allowed before the output responds.

MCLMetal Contact Limit (MCL)

This output will change state when the “Metal Contact” count is equal to or greater than the configured “**MCLT**”.

MCLTMetal Contact Count Limit (MCLT)

Amount of counts allowed before the output responds.

MPLMulti Pinhole Limit (MPL)

This output will change state when the “Multi Pinhole” count is equal to or greater than the configured “**MPLT**”.

MPLTMulti Pinhole Count Limit (MPLT)

Amount of counts allowed before the output responds.

GBLGross Barewire Limit (GBL)

This output will change state when the “Gross Barewire” count is equal to or greater than the configured “**GBLT**”.

GBLTGross Barewire Count Limit (GBLT)

Amount of counts allowed before the output responds.

FCLFault Combination Limit (FCL) – Must be configured via USB computer interface

This output will change state when the conditions of the ‘COLT’ are met.

COLTFault Combination Limit Mode (COLT)

“0”: The output will change state when either the Pinhole Count, or the Multi Pinhole Count are equal to or greater than the “MPLT” or “PHLT”.

“1”: The output will change state when either the Metal Contact count, or the Gross Bare Wire Count are equal to or greater than ‘GBLT’ or ‘MCLT’

ABWAny Barewire Alarm (ABW)

This output will operate in 2 different modes, “**NLC**”, “**LCH**”. The Any Barewire alarm will respond only to a Metal Contact or Gross Barewire fault type. See the “Fault Typing” section of the manual for more information.

ABMOAny Barewire Alarm Mode (ABMO)**NLC**

– Non Latch Mode (NLC)

The output will change state for the configured “ABMS” time.

LCH

– Latch Mode (LCH)

The output will change state until it is reset at the front panel or remotely.

ABMSAny Barewire Alarm Time (ABMS)

Set in seconds (.01 – 5.0). If “**ABMO**” is set to “**NLC**”, this is the time for which the output will change state.

APHAny Pinhole Alarm (APH)

This output will operate in 2 different modes, “**NLC**”, “**LCH**”. The Any Pinhole alarm will respond only to a Pinhole or Multi pinhole fault type. See the “Fault Typing” section of the manual for more information.

APMO

Any Pinhole Alarm Mode (APMO)

NLC

– Non Latch Mode (NLC)

The output will change state for the configured “APMS” time.

LCH

– Latch Mode (LCH)

The output will change state until it is reset at the front panel or remotely.

APMS

Any Pinhole Alarm Time (APMS)

Set in seconds (.01 – 5.0). If “APMO” is set to “NLC”, this is the time for which the output will change state.

Fault Typing

The DC-B has the ability to distinguish between four different types of faults. The four types of faults consist of: *Pinhole*, *Metal Contact*, *Multi Pinhole*, and *Gross Barewire*.

PINHOLE

A high voltage discharge where the electrode does not make physical contact with the conductor of the product being tested.

DIRECT METAL CONTACT

A high voltage discharge where the electrode makes physical contact with the conductor of the product being tested. There is no minimum length detectable, however, electrode design may impact performance of metal contact detection.

MULTI PINHOLE

A series of high voltage discharges, no less than 2.5 x electrode length where the electrode does not make physical contact with the conductor of the product being tested.

Note: Although an accurate line speed is not required for Multi Pinhole Fault Typing, the minimum length typed as a Multi Pinhole Fault, (2.5 x Electrode Length) is reliant on an accurate Line speed.

GROSS BAREWIRE

A period of time, no less than 2.5 x electrode length where the electrode makes direct metal contact to the conductor of the product being tested.

Note: Although an accurate line speed is not required for Gross Barewire Fault Typing, the minimum length typed as a Gross Barewire Fault, (2.5 x Electrode Length) is reliant on an accurate line speed.

Spark Tester Configuration (USB)

Contact factory for details at support@clintoninstrument.com

Testing Your Product

CAUTION: During installation, the spark tester was programmed to report and respond to faults in specific ways. Internal settings must not be changed except by qualified personnel.

1. Place your product in the bead chain electrode. Be sure the wire is centered in the electrode.
2. Verify that the product conductor(s) are grounded. If this is not the case, do not proceed. Contact service personnel to review the spark tester installation.
3. Turn ON the external disconnecting device to bring power to the spark tester.
4. Turn the spark tester power switch ON. Push the front panel 'R' (Reset) button and the 'CR' (Counter Reset) button if necessary, so that the fault counter displays 0.
5. Start the wire line. Press the VOLTAGE ADJUST up arrow button until the voltmeter indicates the desired test voltage value.
6. **CAUTION:** Do not touch the wire while it is being tested.
7. The spark tester will operate in accordance with the settings selected during "Installation" and "Front Panel Programming."

CAUTION: When the spark tester is operated with bare wire in the electrode for an extended length of time, i.e., several minutes or longer, damage to the equipment may result. This condition should be avoided, either by switching the spark tester OFF manually or by a zero speed switch operated by the machinery. Similarly, if the HV remains ON in the electrode while your wire line is stationary, the product insulation within the electrode will heat and there is a **danger of combustion**. Refer to the table "Terminal Block Wiring" in the Installation section of this manual on how to safely install your spark tester.

Preparing your Product for Testing

- Ensure that the product to be tested is dry as it enters the spark test electrode. A continuous film or sheath of water on the product can provide an effective electrical path to the nearest grounded point. Surface leakage can trigger a false count in the spark tester.
- Ground the product conductor(s). This is a safety precaution as well as a requirement of most spark test specifications. Please see the paper, "Grounding of Conductors during the Spark Test," included in this manual.
- Position the product in the center of the electrode, through the safety end guards. Be sure it will remain centered as it is being drawn through the electrode assembly. Lateral wire vibration which may be imperceptible can cause phantom faults to register on the spark tester. Properly positioned guides installed at entry to and exit from the electrode can eliminate this condition.

RS-485 Interface

The 9-Pin D-Subminiature connector for the RS-485 Multi-Drop Full Duplex Interface port is located on the back of the spark tester. It is labeled RS-485. The spark tester can receive commands and requests from a computer or PLC through this port.

The RS-485 Port uses a standard Modbus RTU communication protocol. For Parameter Addresses see the section entitled "[Field Bus Parameter Address](#)".

RS-485 Connector

The pin configuration for the RS-485 port is listed in the table below.

Pin #	Name
1	TX-
2	TX+
3	RX-
4	RX+
5	GND
6	NC
7	NC
8	NC
9	NC

RS-485 Parameters

The default parameters of for the RS-485 Serial port as listed below. To change the port address or the baud rate see the Configuration Menu Options. Note if the unit is being controlled directly from the RS-485 port on the back panel, the PLC will need to poll REMOTE ENABLE (location 5) at least every 500ms to keep the unit from turning off the voltage.

The default Parameters are listed in the table below.

Parameter	Default Value
Baud Rate	19,200
Data Bits	8
Stop Bits	1
Parity	None
Flow Control	None
Station Number	10

Analog Interface

Analog Interface Pin Functions

Pin No.	Description	Function	Notes
1	Remote Process control pulse (collector)	This output will activate when any fault type is detected and will remain on for the Any Fault Alarm Time.	Max. Voltage 30V DC, Max. Current 150mW.
2	Remote Process control pulse (emitter)		Max. Voltage 30V DC, Max. Current 150mW.
3	Remote Bare Wire pulse (collector)	This output will activate when any bare wire type fault is detected and will remain on for the Any Bare Wire Alarm Time.	Max. Voltage 30V DC, Max. Current 150mW.
4	Remote Bare Wire pulse (emitter)		Max. Voltage 30V DC, Max. Current 150mW.
5	Local/Remote Source	When the spark tester is turned ON, a +12V or a +24V at this pin will change the voltage setting from LOCAL to REMOTE. Only then can an analog voltage control the spark tester voltage through pin 6. The voltage control on the front panel of the spark tester will be disabled.	
6	0-10 input control voltage	If pin 5 is set to REMOTE, a 0-10V DC voltage input at this pin changes the spark tester's output voltage proportionally	
7	Remote Fault pulse (collector)	This output will activate when any fault type is detected and will remain on for the Fault Pulse Time.	Max. Voltage 30V DC, Max. Current 150mW.
8	Remote Fault pulse (emitter)		Max. Voltage 30V DC, Max. Current 150mW.
9	Ground	0- 10v reference ground.	
10	Ground		
11	Count Reset	A Momentary +12V or a +24V signal at this pin will reset the fault count when remote is Enabled	
12	Count Preset Open Collector	Current sinking NPN open collector output.	Max. Voltage 30V DC, Max. Current 150mW.
13	DC output	This is a +24V DC output which can be used as a voltage source for the Opto Isolated outputs.	
14	Chassis ground, cable shield	This should be used for the cable shield ground connection	
15	0-10v remote output	This is a 0-10V DC output proportional to the spark tester's high voltage output.	1 meg impedance

Fieldbus Communications Interface

The model DC-B can be purchased with an optional Fieldbus Communications Interface. (Model DC-BX) This interface will allow the installation of several communication options. (DeviceNet, Ethernet IP, Modbus RTU, Modbus TCP, Profibus, Profinet). For each interface a EDS file and support documentation will be provided to assist in the integration.

For Parameter Addresses see the section entitled "[Fieldbus Parameter Addresses](#)". For the specific fieldbus specific data see the section entitled "Fieldbus Specific Information".

Fieldbus Communications Parameters

The following table shows the default communication parameters for the various fieldbuses that are supported by the DC-BX Spark Tester. See the section entitled CIC XM Utility for the steps required to modify these parameters. Note, the Data Sizes are fixed and cannot be changed

Interface Types	Parameter	Default
Modbus RTU	Station Number	40
Modbus RTU*	Interface (RS-232 or RS-485)	RS-232
Profibus	Station Address	40
DeviceNet	Node Address	40
Modbus TCP Ethernet IP Profinet	IP Address	10.10.10.101
Modbus TCP Ethernet IP Profinet	Subnet Mask	255.255.255.0
Modbus TCP Ethernet IP Profinet	Gateway	10.10.10.120
Modbus TCP Ethernet IP Profinet	DHCP	Off
Profinet	Station Name**	""
All	Data Sizes	Output: 32 Words *** Input: 32 Words ***

* This is factory set as RS-232. If two wire RS-485 or four wire RS-485 is required, consult the factory.

** On the Profinet module is the Station Name is not set, the MS LED will flash 3 times. This value can be set by the Profinet Master.

*** Specify the Output Words first followed by the Input Words.

Fieldbus Spark Tester Parameter Addresses

The fieldbus parameters are 2 bytes each. The LSB will be at the lower byte offset, the MSB at the higher byte offset. As an example the setpoint is 5000 volts (1388H in hexadecimal). The setpoint is at a word address 6. When reading the two bytes of the setpoint the LSB (value of 88H) would be received first and the MSB (value of 13H) would be received second. Some PLCs start with addresses of 0, some start with 1. The table below assumes the addresses start with 0.

To check the addressing, read from location 103 and you should read back a value of 15000.

Command	Address	R/W	Notes
RESERVED	0	-	
RESERVED	1	-	
REMOVE VOLTAGE COMMAND	2	W	Will turn off/on the voltage without changing the setpoint
AF RESET COMMAND	3	W	Will reset All Fault Alarms
REMOTE ENABLE	4	RW	Enables Data writes from External bus
SETPOINT VOLTS	5	RW	Requested voltage in Volts
ACTIVE LINE SPEED	6	RW	Line Speed in ft/m
VMON VOLTS	7	R	Voltage at metering windings (Actual Voltage) in Volts
EVMON VOLTS	8	R	Voltage at Electrode in Volts
IMON PERCENT LOAD	9	R	Percent of maximum load on the system
AF COUNT	10	RW	All fault count
PH COUNT	11	RW	Pinhole fault count
MC COUNT	12	RW	Metallic Contact fault count
MP COUNT	13	RW	Multi-pinhole fault count
GB COUNT	14	RW	Gross Bare Wire fault count
STATUS FLAGS 0	15	R	See Definitions below
STATUS FLAGS 1	16	R	See Definitions below
ALARM_MODES	17	RW	AF, ABW, APH*
AF_ALARM_MS	18	RW	
ABW_ALARM_MS	19	RW	
APH_ALARM_MS	20	RW	
AF_LIMIT_VALUE	21	RW	
PH_LIMIT_VALUE	22	RW	
MC_LIMIT_VALUE	23	RW	
MP_LIMIT_VALUE	24	RW	
GB_LIMIT_VALUE	25	RW	
GPO_0_1_FUNCTION	26	RW	function for both GPO_0 and GPO_1***
GPO_2_3_FUNCTION	27	RW	function for both GPO_2 and GPO_3***
AV_WDL_LOW_VOLTAGE	28	RW	
AV_WDL_HIGH_VOLTAGE	29	RW	

* The value for the alarm modes is as follows: AF_ALARM *16 + ABW_ALARM * 4 + APH_ALARM

** The values are: 0 – startup, 1111h – initialization, 5555h- interface online (ready)

*** The lower value (GPO_0 or GPO_2) is in the LSB and the upper in the MSB

Below are the individual bits for Status Word 0			
GLOBAL VOLTAGE ENABLED	Bit 0	R	Set when all conditions allow voltage to be generated
AV HVL STATUS	Bit 1	R	Set when the Actual Voltage >= HVL On voltage
AV WDL STATUS	Bit 2	R	Set when voltage is in the range of the Watchdog Low and High levels
FP STATUS	Bit 3	R	Set when the fault is detected and cleared at end of fault pulse duration
AF ALARM STATUS	Bit 4	R	State of the AF Alarm cleared by Fault Reset
PH ALARM STATUS	Bit 5	R	State of the PH Alarm cleared by Fault Reset
MC ALARM STATUS	Bit 6	R	State of the MC Alarm cleared by Fault Reset
MP ALARM STATUS	Bit 7	R	State of the MP Alarm cleared by Fault Reset
GB ALARM STATUS	Bit 8	R	State of the GB Alarm cleared by Fault Reset
AF COUNT LIMIT STATUS	Bit 9	R	Set if AF Count >= AF Count Limit cleared by Fault Count Reset
PH COUNT LIMIT STATUS	Bit 10	R	Set if PH Count >= PH Count Limit cleared by Fault Count Reset
MC COUNT LIMIT STATUS	Bit 11	R	Set if MC Count >= MC Count Limit cleared by Fault Count Reset
MP COUNT LIMIT STATUS	Bit 12	R	Set if MP Count >= MP Count Limit cleared by Fault Count Reset
GB COUNT LIMIT STATUS	Bit 13	R	Set if GB Count >= GB Count Limit cleared by Fault Count Reset
FAULT COMBO LIMIT STATUS	Bit 14	R	Set if Fault Combo Count >= Fault Combo Count Limit cleared by Fault Count Reset
AVSP WD PERCENT STATUS	Bit 15	R	Set when Actual Voltage is within the AVSP Percent of the Setpoint
Below are the individual bits for Status Word 1			
EVSP WD PERCENT STATUS	Bit 0	R	Set when Electrode Voltage is within the EVSP Percent of the Setpoint
ABW ALARM STATUS	Bit 1	R	Indicates a Bare Wire fault has been detected cleared by Fault Reset
APH ALARM STATUS	Bit 2	R	Indicates a Pinhole fault has been detected cleared by Fault Reset
GPO 0 STATUS	Bit 8	R	State of General Purpose Output 0
COVER_OPEN_STATUS	Bit 3	R	Indicates the cover state: 1 – Cover Closed, 0 – Cover is Open
PERCENT_LOAD_LIMIT_STATUS	Bit 4	R	Indicates if the Percentage Load Limit has been reached or exceeded
GPO 1 STATUS	Bit 9	R	State of General Purpose Output 1
GPO 2 STATUS	Bit 10	R	State of General Purpose Output 2
GPO 3 STATUS	Bit 11	R	State of General Purpose Output 3
GPI 0 STATUS	Bit 12	R	State of General Purpose Input 0
GPI 1 STATUS	Bit 13	R	State of General Purpose Input 1
GPI 2 STATUS	Bit 14	R	State of General Purpose Input 2
GPI 3 STATUS	Bit 15	R	State of General Purpose Input 3

CIC XM Utility

To configure any of the active CompactCom™ modules (DeviceNet, Ethernet IP, Modbus RTU, Modbus TCP, Profibus, Profinet), plug in a micro-USB (shown on below left) or USB “B” (on below right) cable and run the CIC XConfig Utility. If the USB cable is not connected the CIC XConfig Utility will prompt for the USB cable as shown.



After the cable is connected you will get the following option screen.

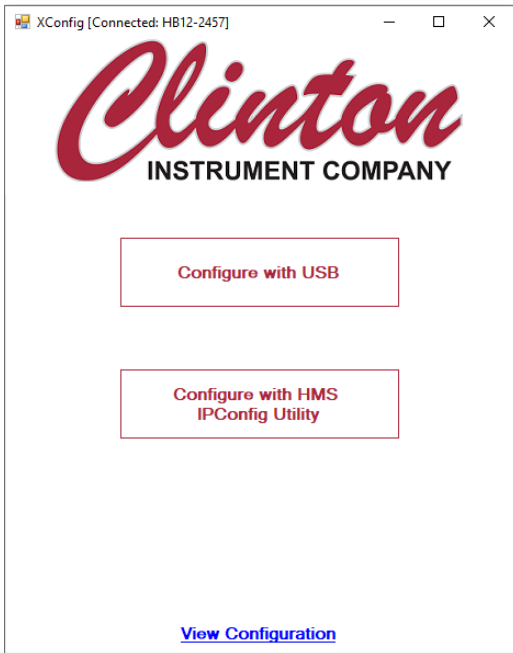

Select **“Configure with USB”** to configure with the XConfig Config utility.

Select **“Configure with HMS IPConfig Utility”** to configure through the field bus. Once the power is cycled to the spark tester it will be ready to configure with the IP config utility. This utility can be found at Anybus.com.

When configuring through the USB port one of the following screens will be presented. The first is for Ethernet based fieldbus types (Ethernet IP, Modbus TCP and Profinet) shown on the left. The second type of edit screen is for non-Ethernet based fieldbuses (DeviceNet, Profibus, Modbus RTU) shown on the right.

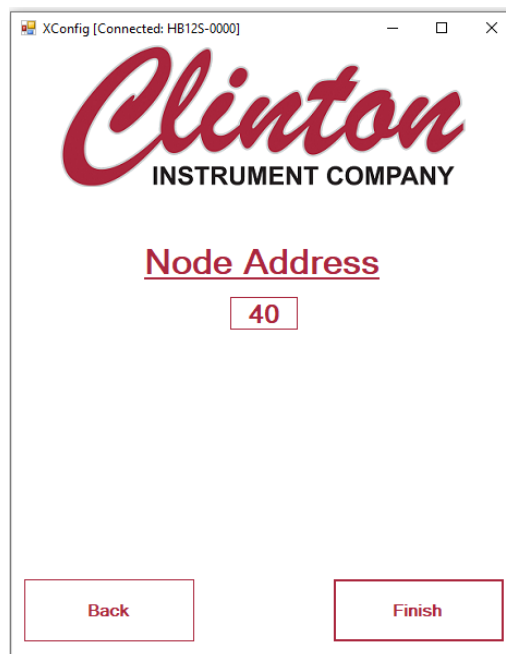
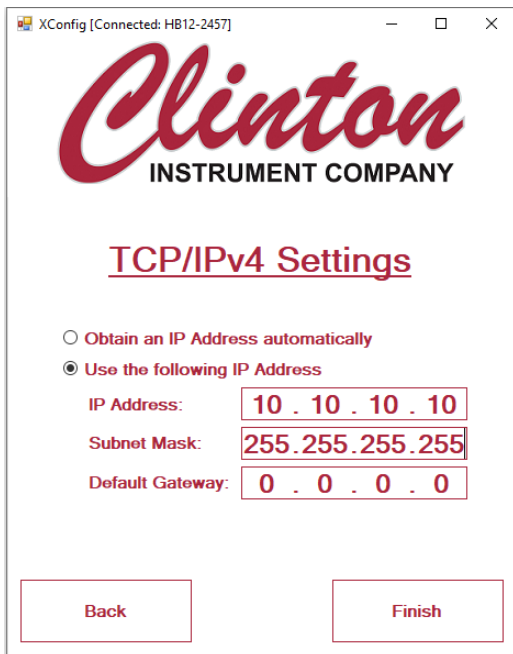

Update the IP Address information or the Node Address.

Once edits are complete, press the Finish Button. The following screen will be shown indicating a power cycle is required.

Once power has been cycled the new values will be used.

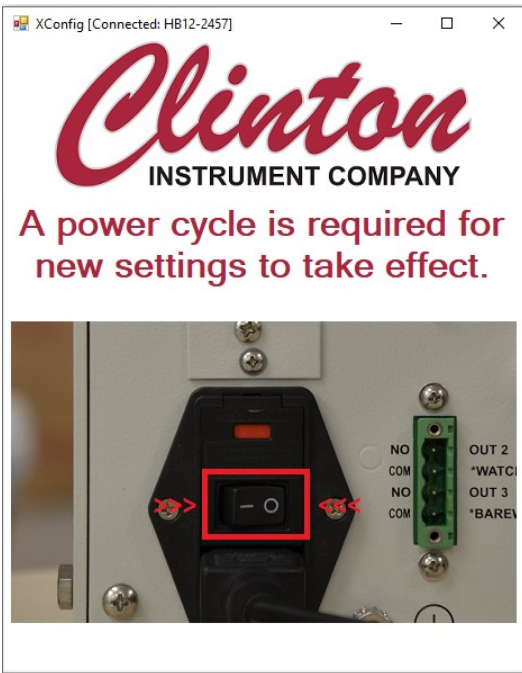

Calibration

The Spark Tester may be reasonably expected to retain its accuracy for a period of one year from the date of calibration under conditions of normal use.

CAUTION: The calibration procedures listed below are to be performed by qualified service personnel experienced in high voltage safety procedures only. Failure to follow these procedures may result in danger to personnel and equipment.

The following is a list of recommended equipment for use in calibrating the DC-B.

- Electrostatic Voltmeter (EVM) – Manufactured by Sensitive Research
- ST-CAL with LFVM – Manufactured by Clinton Instrument Company

ST-CAL Calibration

The DC-B can be calibrated through an automated process using the STCAL system with an LFVM.

To perform the calibration with the STCAL please follow the instructions for the STCAL system.

EVM Calibration Procedure

The EVM has a mirrored area to assist in eliminating errors in reading. The correct way to read the meter is to move the viewing position (your eye) until the reflection of the needle in the mirror is directly behind the needle itself and observe the needle position on the scale. This eliminates any parallax error that might result from viewing the meter at a slight angle.

Connecting the EVM

1. Before connecting to the EVM, turn ON the spark tester and adjust the voltage to 0 using the VOLTAGE ADJUST down arrow button. Turn OFF the spark tester.
2. With the power to the RC and DC-XXB Spark Tester turned off connect the high voltage input on the EVM to the Spark Tester electrode. Use the shortest high voltage lead possible. For bead chain and brush electrodes connect the alligator clip directly to the electrode. For roller type electrodes you may need to wrap the high voltage roller with un-insulated wire and connect the alligator clip to the wire.
3. Set the EVM range Selector to the 5kV range. Then Zero the EVM.

Taking Calibration Readings

4. Turn on the RC and DC-XXB and adjust the spark tester voltage to 3.00KV. Record the voltage reading on the EVM.
5. Repeat this step for all required test voltages in the current test voltage range of the EVM.
6. Turn off the spark tester and adjust the EVM range to for the remaining readings. Repeat these steps for all required test voltages.

Note: Each time the Range is changed on the EVM the needle should be adjusted to Zero.

Adjusting the Calibration

Entering the Calibration Mode

7. Press and hold the Down Arrow Button and the CR Button for approximately 4 seconds. The spark tester will enter the configuration mode and disable the high voltage output.
8. If the display is locked, you will need to unlock the display with the PIN. See "[RC Security](#)" section for more information.
9. Press the Down Arrow until "MCAL" is displayed on the voltage display.

Adjusting the Spark Tester Output voltage and Voltage Monitor

10. Press the "B" button for several seconds until "VOUT" is displayed on the voltage display.
11. Press the "R" button. The Fault Count display should show "S.00.0" representing the set point value.
12. Using the UP/DOWN arrows adjust the output voltage up so that the Fault Count display shows "S.01.0" for 1kV.
13. Check the actual output voltage on the EVM, if this value is not within the rated specification for the DC-XXB Press the "CR" button. The Fault Count display will change to "* .01.0".
14. Using the UP/DOWN arrows adjust the reading on the EVM until the reading is within the rated tolerance for the DC-XXB or as close to the value on the Fault count display.
15. Once the EVM and the value on the Fault Counter match press the "R" button two times to display the nominal voltage value "01.0".
16. Press the DOWN arrow and "VZER" is displayed on the voltage display.
17. Press the "B" button once and the VMON and EVMON are automatically adjusted.
18. Press the UP button and "VOUT" is displayed on the voltage display.
19. Repeat these steps until all calibration values are within tolerance.
20. Once calibration is complete press the "A" button once to exit the Manual calibration mode.

Note: Calibration intervals begin at 1kV and are to be performed at 1kV increments.

Maintenance

Fuses

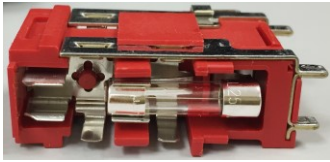

The fuses in this equipment are not expected to fail in normal operation. Their failure may be an indication of equipment malfunction requiring qualified repair personnel.

There is one fuse associated with the spark tester's operating voltage, located in the ON/OFF power switch on the back panel of the unit.

Two additional fuses that could be defective are found on the relay output printed circuit board, behind the back panel.



Fuse

Relay Fuse



Periodic Inspection

It is important to inspect the electrode and electrode mounting plate periodically for residue and wear.

Insulation and water deposits can reduce the effectiveness of the spark test. The red electrode mounting plate may be wiped with a clean, dry cloth. Bead chain assemblies contaminated with insulation residue should be removed from the high voltage test module and cleaned with a wire brush. Broken safety covers and mounting plates and electrode assemblies with worn brushes or missing beads should be replaced immediately.

The red electrode mounting plate, clear cover, and bead chain assemblies are subject to damage and contamination that is not always visible. They should be replaced if current leakage occurs.

Refer to the "Troubleshooting" section for assistance with electrical problems.

Troubleshooting

CAUTION: Troubleshooting is to be performed by qualified service personnel only. Failure to follow the procedures in this manual may result in danger to personnel and equipment damage.

Phantom Faults are being indicated.

1. Lateral wire line vibration or water may be present. See “Installation” for information on drying, centering and restraining the product in the electrode.
2. The high voltage mounting plate may be contaminated with dirt or conductive material. Clean the mounting plate or replace.
3. Inspect proper grounding of inner conductor.
4. If, after 1,2,& 3 have been corrected, you still experience false counting due to a capacitive loading effect on your test product, change the “FD-CON” setting in the Configuration menu from “NOR” to “RED”. Note that your spark tester will no longer meet the BS Standard for sensitivity but will still meet the NEMA Standard for sensitivity.

The Fault Count Displays “E.EXI”

1. There is no switch or relay contact between Pins 1 & 2 (GND and HV ENABLE). Refer to the table in “Installation” labelled “Terminal Block Connections,” under HV ENABLE.

The Fault Count Displays “E.CV0”

1. The clear safety cover is open.

The Fault Count Displays “E.RVF”

1. The voltage was removed due to the spark tester being in the remove voltage on fault mode. To clear this press the “R” button on the front panel.

The Fault Count Displays “E.RVC”

1. The voltage was removed by a command through either the RS-485 serial interface or through the fieldbus port. The voltage will need to be re-enabled through that port.

The Fault Count Displays “E.HVD”

1. The high voltage will not turn on due to a possible hardware failure. Please contact the Clinton Instrument Company for assistance

After adjusting the voltage with the product in the electrode, a lower voltage is displayed.

1. The spark tester may have reached the highest voltage possible for this product due to a capacitive loading effect from the test product. Consult the factory regarding your application.

Equipment at relay terminals COM and NO or NC is not activating when fault occurs

1. The PCD (Process Control Duration) value may be too short for the auxiliary equipment to recognize.
2. Check fuse on main pc board.

The spark tester controls are on but the equipment does not function.

1. The high voltage test module interlock switch is not closed.
2. The terminal block connector is not plugged in.
3. F101 fuse is blown.
4. There is no switch or relay contact between Pins 1 & 2 (GND and HV ENABLE). Refer to the table in "Installation" labelled "Terminal Block Connections" under HV ENABLE.

I forgot my PIN code

Contact factory for details at support@clintoninstrument.com

Setting Factory Defaults

When factory defaults are set from the configuration menu, the unit will restore all settings to the default values. The only exceptions are that Serial Numbers and Calibration Information will be saved so that the unit will not need recalibration.

Replacement Parts

Part Number	Description
02606	2 amp low breaking time delay fuse, 5x20mm
92281	3 amp low breaking time delay fuse, 5x20mm
91061	Power entry module (ON/OFF Switch)
RC	Display unit complete
92250	Power Supply 200W 48VDC
92348i	Assembly PCB DC-B Main
92286	Assy Heat Sink DC-B
BD-12S	Assy Bead Chain BD-12 W/Split Trough
92267	Assy Bead Chain only for BD-12S (Requires 2)
91048	Electrode Mounting Pate for BD-12, BD-13
92240i	Cover Clear Safety for BD-12, BD13
92264	Hinge Surface Mount 40 Series (Requires 2)
92xxxi	High Voltage 1kV DC-Supply
92xxyi	High Voltage 10kV DC-Supply
92xxzi	High Voltage 20kV DC-Supply
03004	Switch, Interlock
92283	4 – Pin Terminal Block Connector Kit (Green)
91069	9 – Pin Terminal Block Connector Kit (Green)
03780	Power Cord
91463G	End Guard DC-B/BD-12 and BD-13
91326	BD-22S Bead Chain Assembly
92241i	Cover Clear Safety for BD-22
01554	Standoff-Ceramic
90819	Rubber Gasket for 01554
91113	Electrode Mounting Plate for BD-22
91111G	End Guard BD-22
92211	Front Panel for RC Display

Note: Printed circuit boards are carefully constructed and calibrated at the factory. Components are not supplied for field repair of boards. Please return faulty circuit boards to the factory or to your Clinton sales representative for evaluation.

Optional Accessories

Part Number	Description
FS-4	Floor Stand for DC-B, 39-42" Adjustable wire line height
FS-4A	Floor Stand for DC-B with BR-3A or BRTC electrodes
X3B W/91224G Plate	Horn/Light for DC-B/BD-12S
X3B W/91223G Plate	Horn/Light for DC-B/BD-22S
STCAL-LF	STCAL Low Frequency Calibration System
STCAL-SM	Sensitivity Test System
DC-SP	Probe Sensitivity for DC

Warranty

The information contained in this document is subject to change without notice. The Clinton Instrument Company makes no warranty of any kind with regard to this material, including, but not limited to, the implied warranties or merchantability and fitness for a particular purpose.

The Clinton Instrument Company shall not be liable for errors contained herein or for incidental damages in connection with the furnishing, performance, or use of this material.

We warrant to the original purchaser that the equipment described herein is free from defects in materials and workmanship for a period of one year from the date of invoice, our obligation under this warranty being limited to repair or replacement of the defective parts. This warranty does not apply to fuses, lamps, or any normally expendable parts. Any part appearing to have defects in material or workmanship, upon our examination only and as determined by us, and providing the equipment has not been subject to abuse, misuse, or alteration, will be repaired or replaced at no charge for materials and labor, either upon receipt of the defective part or equipment, transportation charges prepaid, at our plant or at the equipment location, as selected by us. No parts or equipment shall be returned without our prior permission. Any parts replaced under this warranty shall be warranted until the expiration date of the original warranty.

The warranties herein are in lieu of all other warranties, expressed or implied, and of all other obligations or liabilities on our part concerning this equipment.

FS-4 Floor Stand Assembly

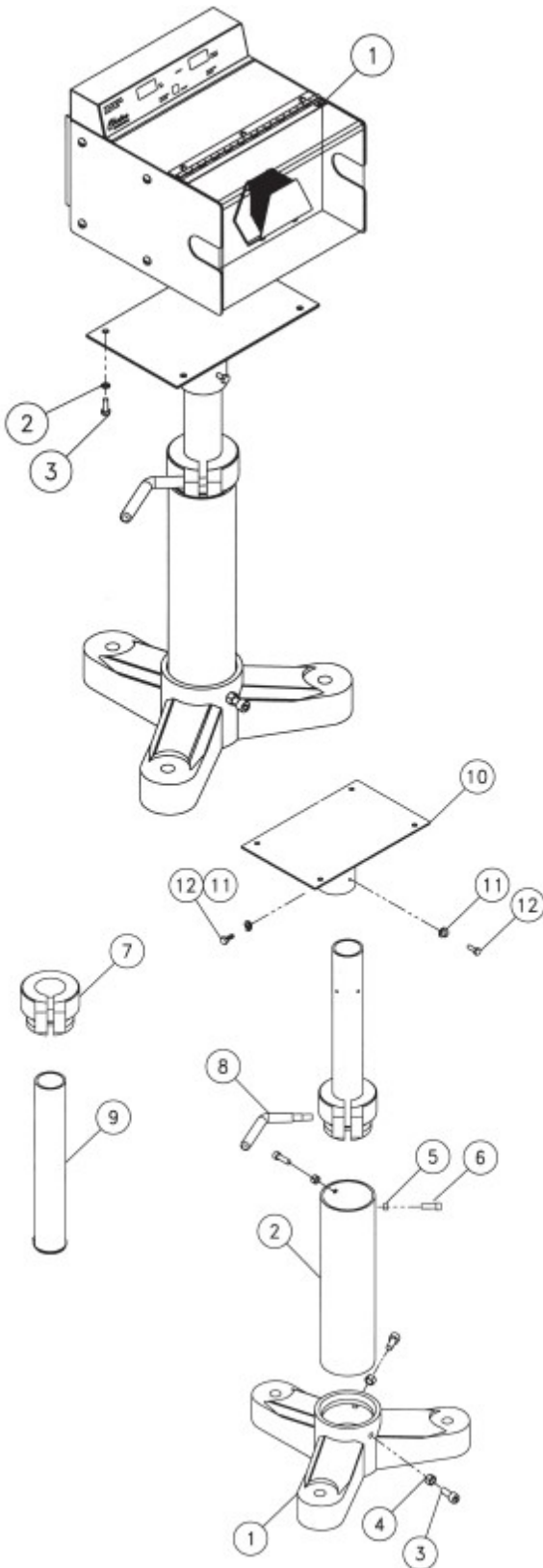

Item No.	Item Description	Qty.
1	Test Module	1
2	6 mm Split Lock Washer	4
3	M6 x 16 Hexhead Screw	4

Item No.	Item Description	Qty.
1	Base	1
2	Outer Column	1
3	10-1.5 x 30 mm bolt	2
4	10-1.5 mm Hex Nut	2
5	8 x 1.25 mm Hex Nut	2
6	8-1.5 x 25 mm Bolt	2
7	Column Clamp	1
8	Handle	1
9	Inner Column	1
10	Test Module Mounting Plate	1
11	M6 Split Washer	2
12	M6 x 16 mm Bolt Hex	2

Grounding of Conductors during the spark test

MEASURING & TESTING



Grounding of conductors during the spark test

by Henry Clinton

Nearly all industry-wide specifications for insulated wire and cable pertaining to in-line spark testing require the grounding or earthing of the conductors under test. It is the purpose of this discussion to examine the reasons for this and to define the conditions which allow for a safe and effective spark test when conductors are not grounded. Although this testing mode cannot be used to satisfy most industry specifications, it can be useful when quality must be strictly monitored and conductor grounding is inconvenient or impossible.

D-C spark testing

If a direct potential is used for spark testing, it is absolutely necessary to ground the conductor or conductors under test. In Fig. 1, C_g represents the capacitance of the product to ground, which could be in the range of 100 to 2,000 picofarads, depending on the size and length of the conductor.

If the conductor is not grounded, the potential on the conductor with respect to ground will rise when the first insulation fault passes through the electrode. This is because C_g charges towards the D-C test potential applied to the electrode through the arc.

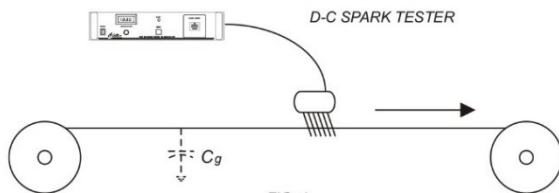

FIG. 1

If the conductor is not grounded but is initially at ground potential, when the first insulation defect passes through the electrode, an arc forms between the electrode and the conductor. The current flowing through this arc charges capacitance C_g , elevating the potential of the conductor by a value which is a function of arc time duration and the value of the current. After the defect or fault has completed its passage through the electrode, C_g retains this elevated potential, since C_g has no discharge path to ground. The effective test potential on the product insulation is now reduced by this retained conductor potential. If a second insulation flaw traverses the electrode, additional charging of C_g takes place, further reducing the effective test potential. Eventually the effective test potential falls below that required to cause an arc to occur on the passage of an insulation flaw, and all subsequent flaws will be undetected. Usually, current and traverse time are large enough to sully charge C_g on the passage of the first flaw, so it will be the only one detected.

Furthermore, the entire length of product is now charged to the test potential. If the operator accidentally comes into contact

with the conductor or with a flawed insulation area anywhere along the wire line, C_g can discharge through his body to ground. If by coincidence a faulted insulation area is within the electrode, the maximum current output of the spark tester can also pass through his body. While this current, in the case of Clinton spark testers, is well below a dangerous level, the involuntary muscular reaction resulting from this event can itself cause a secondary accident.

It is thus apparent that from the dual standpoints of utility and safety the conductors of a product being spark tested with a D-C potential should be grounded.

A-C spark testing, general

If an A-C potential is used for the spark test, and the conductors are not grounded, the diagram in Fig. 2 applies.

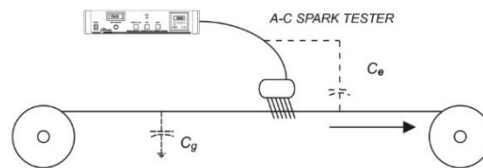
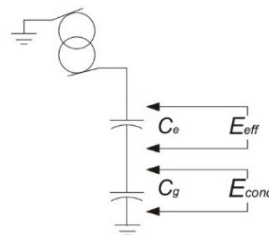

FIG. 2

Note that the electrode to product capacitance C_e is shown, and that C_e and C_g comprise a voltage divider which determines the A-C potential from conductors to ground, and also the effective test potential applied across the product insulation.



$$\frac{E_{eff}}{E_{cond}} = \frac{C_g}{C_e}$$

$$E_{cond} = E_{app} - E_{eff}$$

$$E_{eff} = \frac{C_g}{C_e + C_g} E_{app}$$

If C_g is very large compared to C_e , E_{eff} is nearly equal to E_{app} . For example, if $C_e = 5\text{pf}$ and $C_g = 1000\text{pf}$, 99.5% of the applied test potential is impressed across the product insulation. If C_g is 100pf, however, the effective test voltage drops to 95% of the applied value.

Power mains frequency testing

When an insulation defect passes through the electrode, the arc which forms to the ungrounded conductor in effect connects the conductor to the electrode. If the spark tester operates at the

MEASURING & TESTING

mains frequency, the ungrounded conductor will be elevated to nearly the full test potential. If an operator comes into contact with a bare spot in the insulation at this time, current can flow through his body to ground. The maximum value of this current will be the maximum output level of the spark tester. For Clinton mains frequency spark testers this level is less than the "let-go" threshold and is not dangerous in itself. However, as in the D-C case, the event is unexpected and unpleasant, and can lead to a secondary accident. From the standpoint of flaw detection, the detector circuitry must differentiate between normal electrode current and the new level when the arc connects C_g to the electrode, which is a small increment. As in the D-C case, grounding of the conductors under test is a practical necessity.

High Frequency spark testing

When the A-C test frequency is increased to 3Khz, two dramatic changes occur. First, because a short electrode is used, the capacitance to the conductor C_e is kept small. For a 2 in. electrode C_e might be typically 2 to 20pf, increasing with the applied potential. The other change is the low reactance of C_g , which allows the current to be conducted readily to ground through a capacitive path rather than by direct connection.

The ratio of C_g/C_e is usually high, so that nearly all of the applied test potential appears across the product insulation. When an insulation flaw passes through the electrode, current drawn from the spark tester increases sharply in this same ratio, subject to the current limiting characteristics of the test equipment. This

means that flaws can be detected reliably. If required, C_g can be increased by passing a considerable length of the product close to the grounded surface.

Although the maximum resistive current which can be delivered by a Clinton 3Khz spark tester is well below the "let-go" threshold, a mild shock could still be experienced if an operator contacts a bare spot on the product while a second defect is in the electrode. For this reason the entire line should be provided with protective guards to prevent this.

The ratio of C_g/C_e can be experimentally determined by measuring E_{cond} , the conductor to ground potential, with a high impedance A-C volt-meter or an oscilloscope.

$$\frac{C_g}{C_e} = \frac{E_{app} - E_{cond}}{E_{cond}}$$

Summary

Spark testing of ungrounded conductors is usually not permitted by industry-wide specifications, and is unsatisfactory in any event if D-C or A-C power mains frequency test potentials are used. A satisfactory test for quality control purposes can be made on ungrounded conductors at 3Khz, however, if proper precautions are followed.

Henry Clinton is president of Clinton Instrument Co., Clinton, CT.

CLINTON INSTRUMENT COMPANY

295 East Main Street

Clinton, CT 06413 USA

Telephone: 860-669-7548 Fax: 860-669-3825

Electronic Instrumentation For Industry